

Mini-ITX D2963-S

TechNotes V1.0

First Release

Mainboard OEM Sales - 01/2010

- Safety Instructions à Page 2
- Mainboard Overview & Benchmarks à Page 3
- Display Options à Page 10
- Power Supply Features à Page 25
- Internal Connectors à Page 35
- System Monitoring à Page 48
- Temperature Reference Overview à Page 63
- Mainboard Power Consumption à Page 66
- Special Features à Page 68
- Operating System Support à Page 71

- OEM FTP download link for D2963-S

<ftp://ftp.ts.fujitsu.com/pub/Mainboard-OEM-Sales/Products/Mainboards/Industrial&ExtendedLifetime/D2963-S/>

(provides BIOS; Drivers; Documents & Approvals; Specifications; Tools etc.)

Do not connect or disconnect any cables or modules to or from any onboard connectors (except for the rear I/O connectors) until the mainboard is completely powered down.

Any damage caused to the mainboard by misuse of the onboard connectors is excluded from the standard warranty. Fujitsu Technology Solutions cannot be held liable for any damage that results from incorrect use of any onboard connectors.

The system integrator is fully responsible for the usage of appropriate connectors and cables in order to fulfill the technical requirements (electrical contact, durability, power/current levels, signal integrity etc.)

Overview

- Onboard interfaces & connectors

Onboard Components

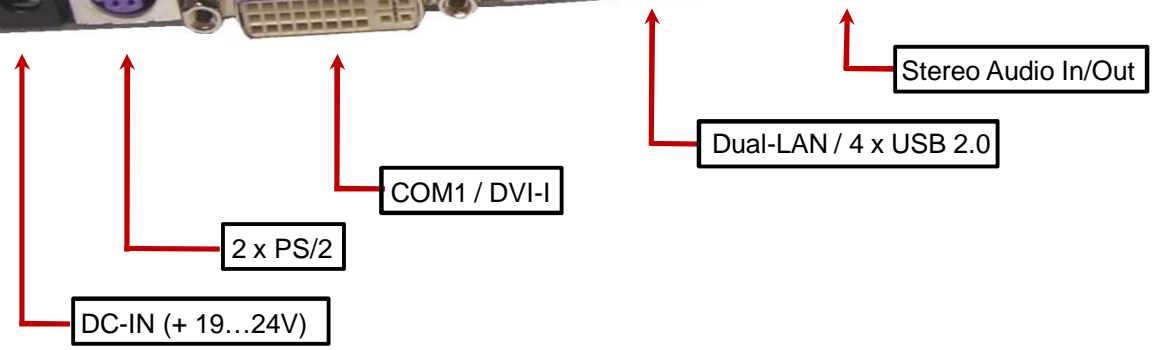
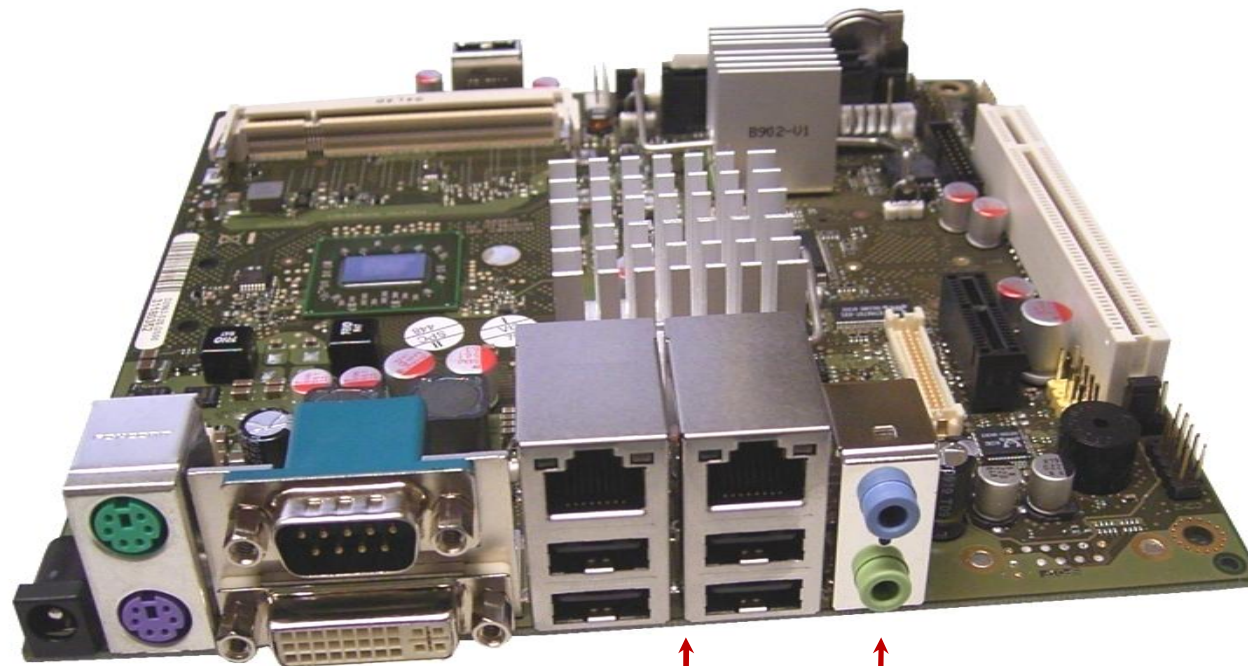

PCB: 8-layer

Onboard Components

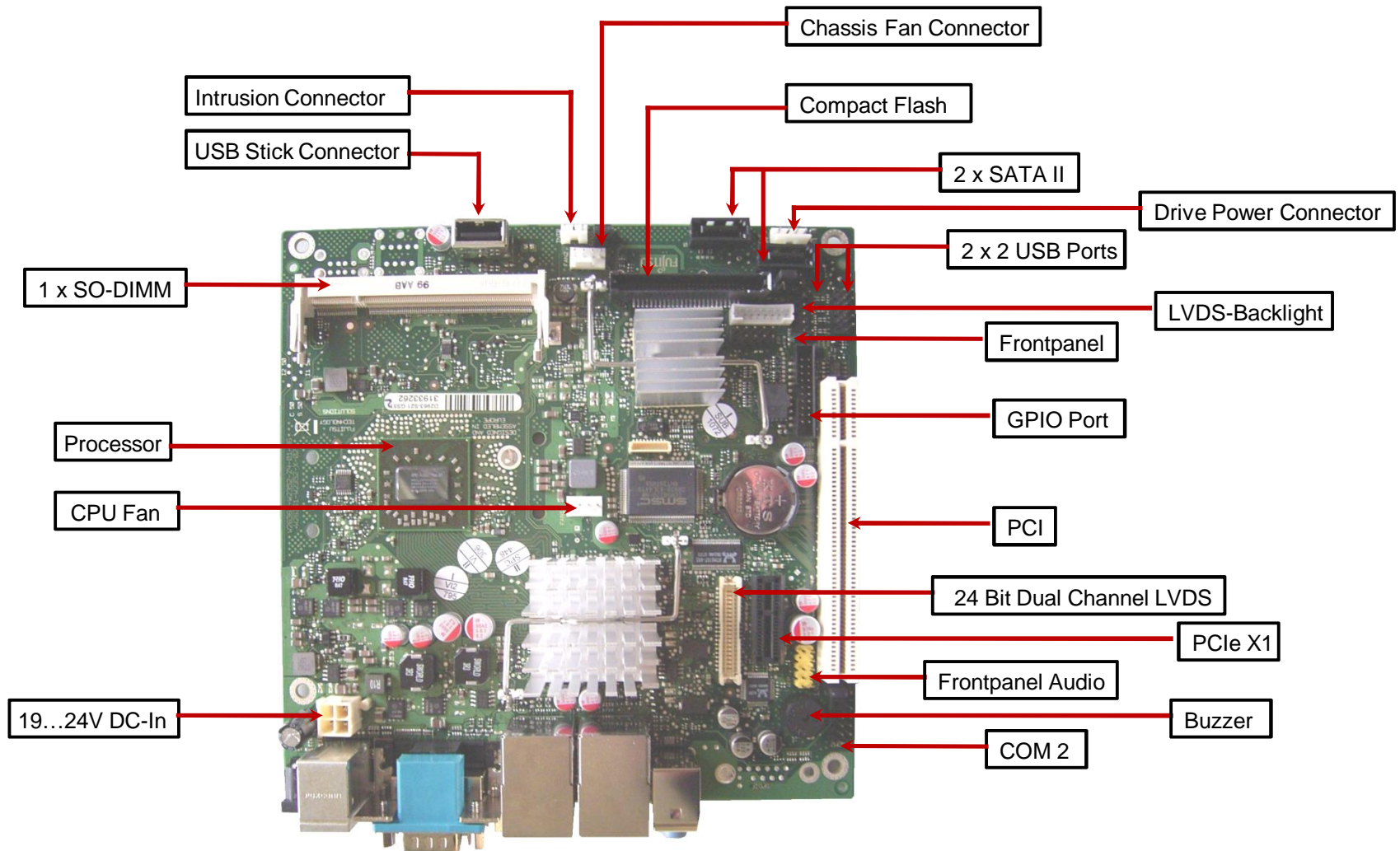

Onboard Components

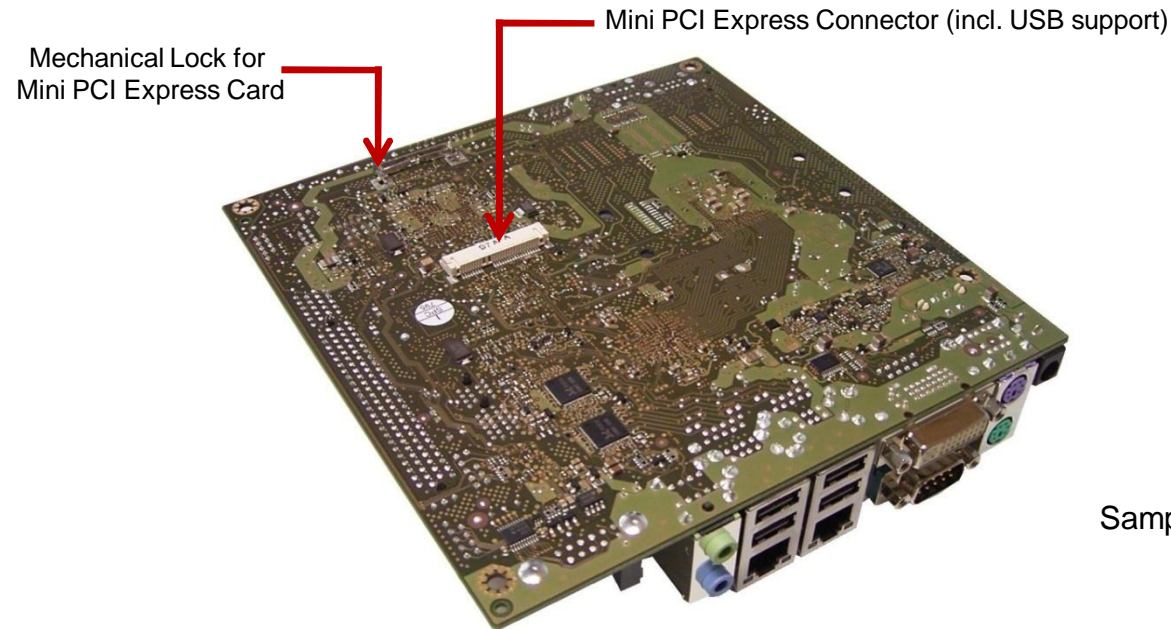

Sample for WLAN Minicard on D2963-S

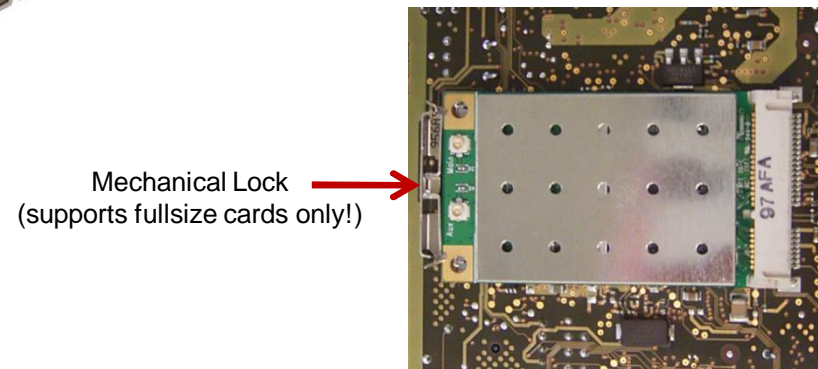

Benchmarks – SysMark 2004SE (Overall Rating)

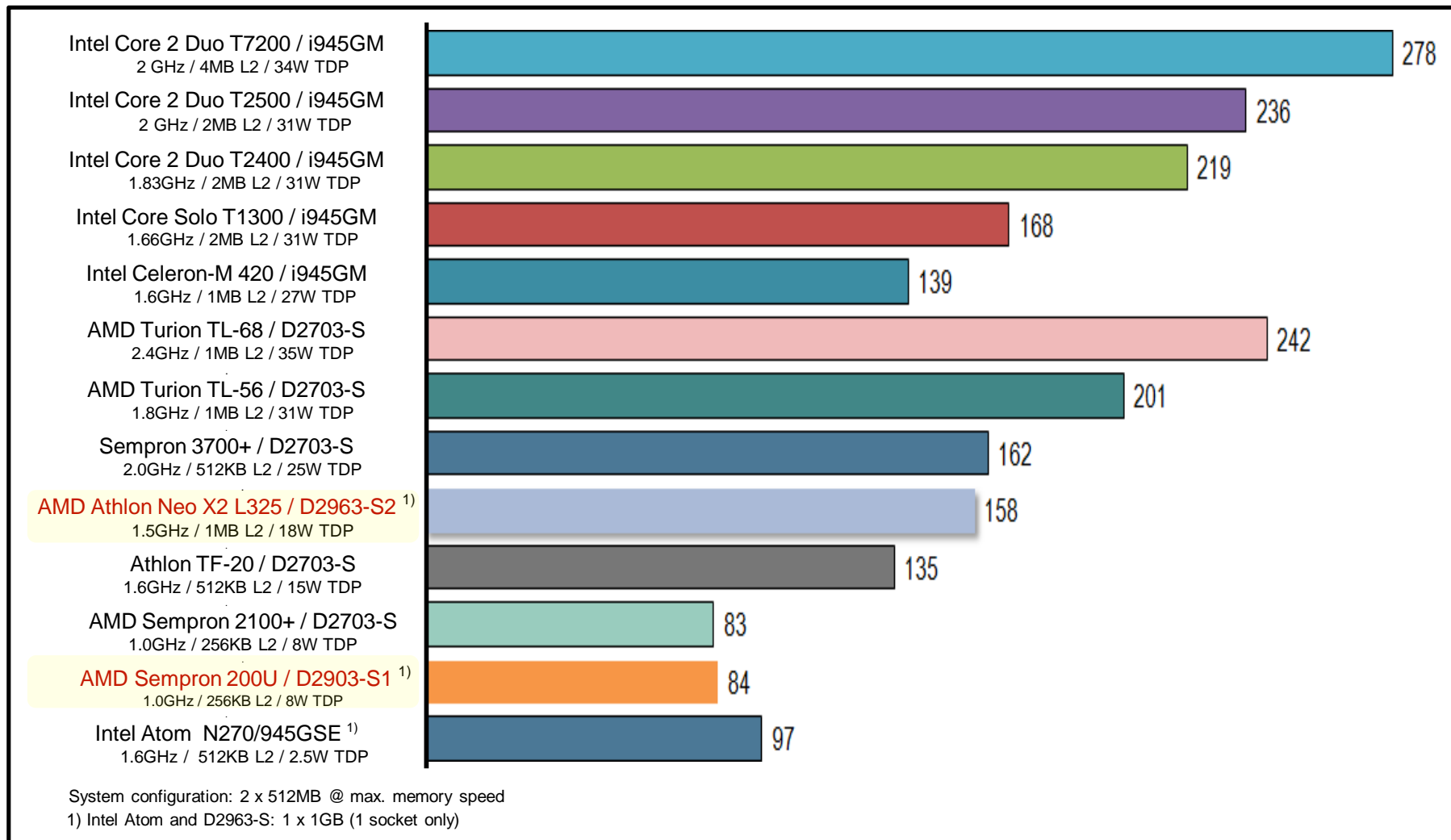

Benchmarks – 3DMark2006

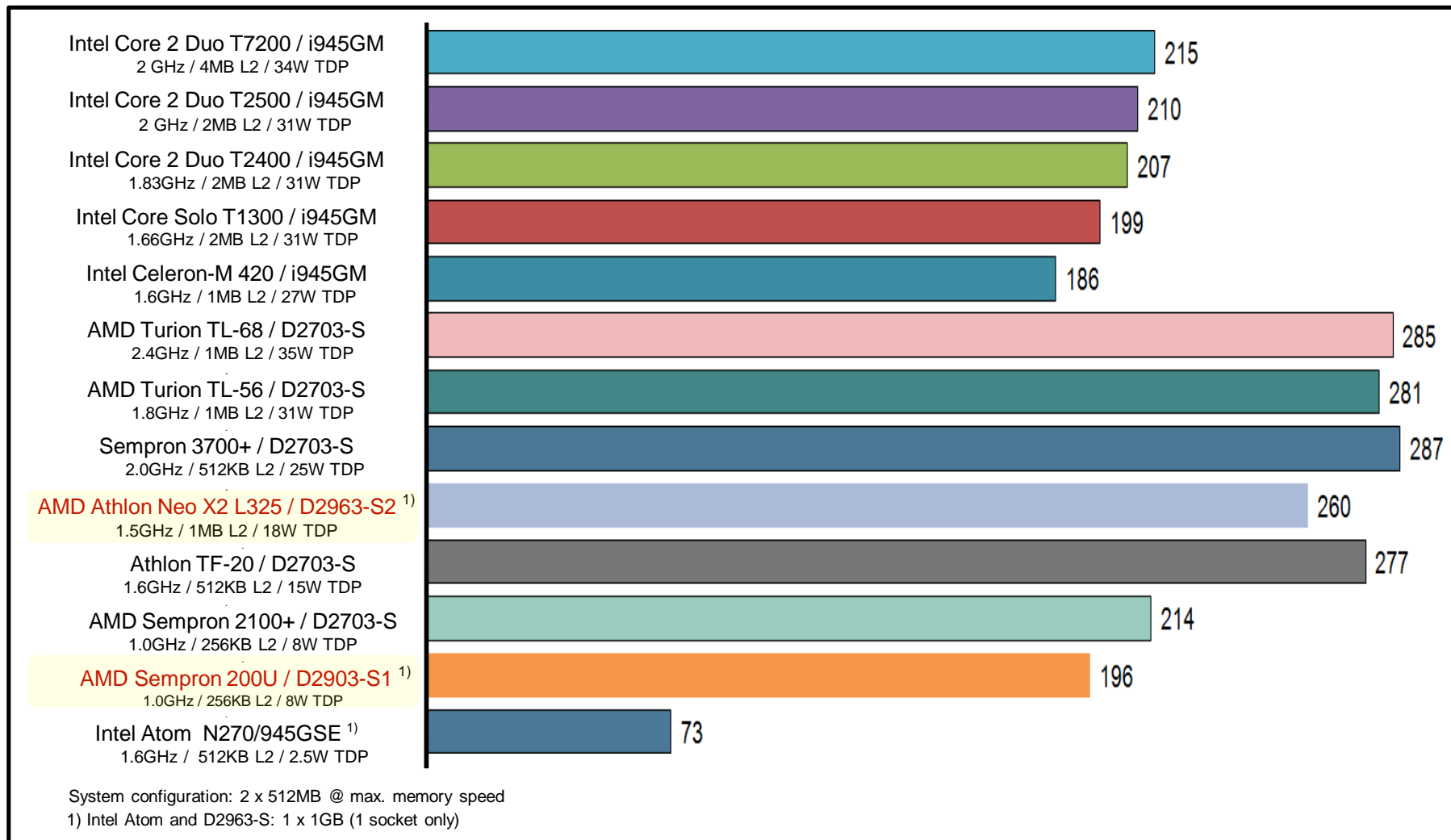

Benchmarks – PCMark2005

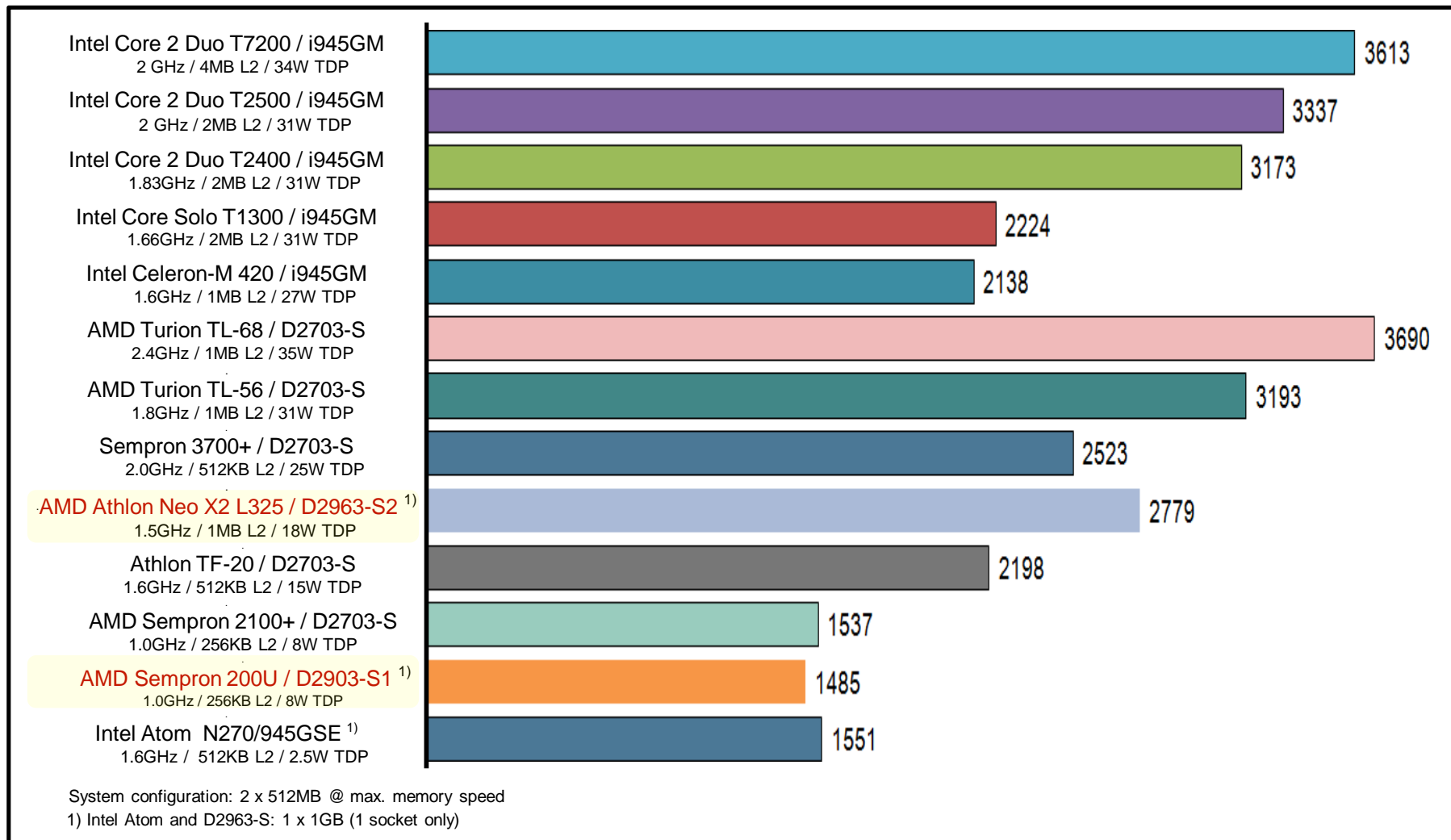

Display Options

- LVDS display & backlight inverter
- LVDS / Inverter connector details
- LVDS timings & screen resolutions
- LVDS cabling reference
- DVI, VGA, HDMI, LVDS

Display Options

LVDS Display & Backlight Inverter

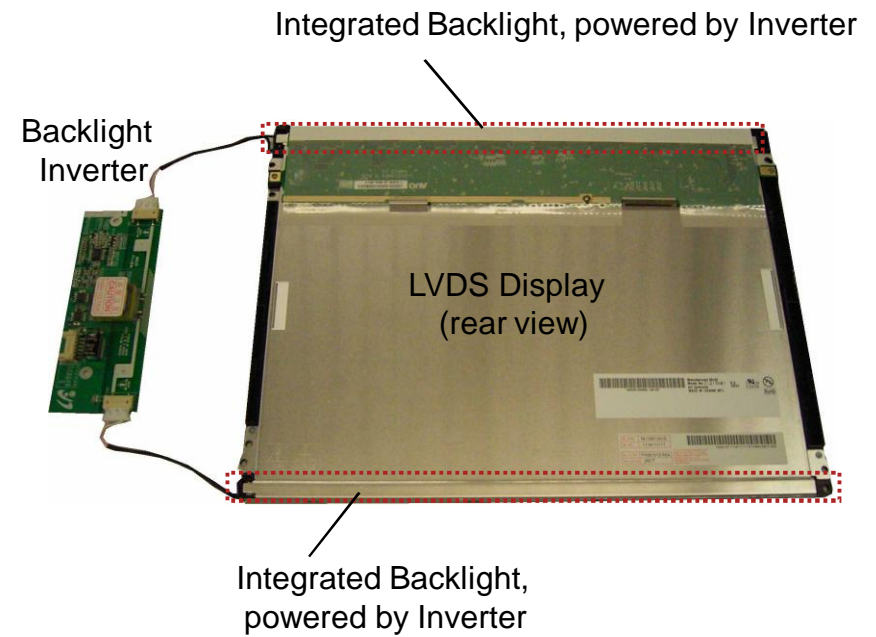
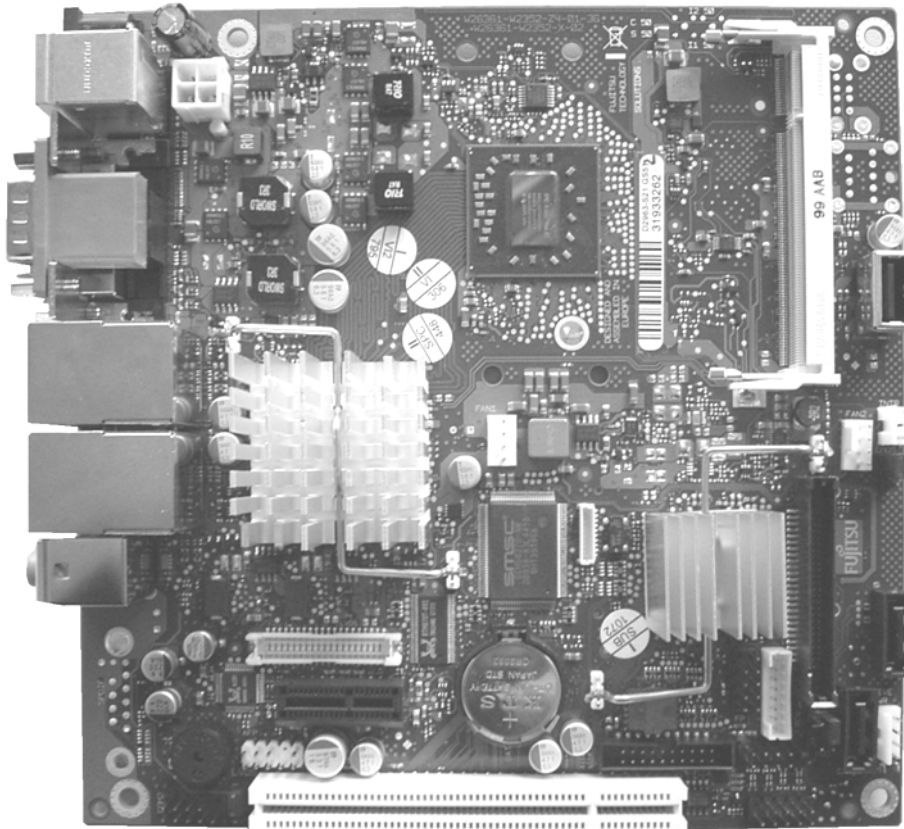

Display Options

LVDS Display & Backlight Inverter

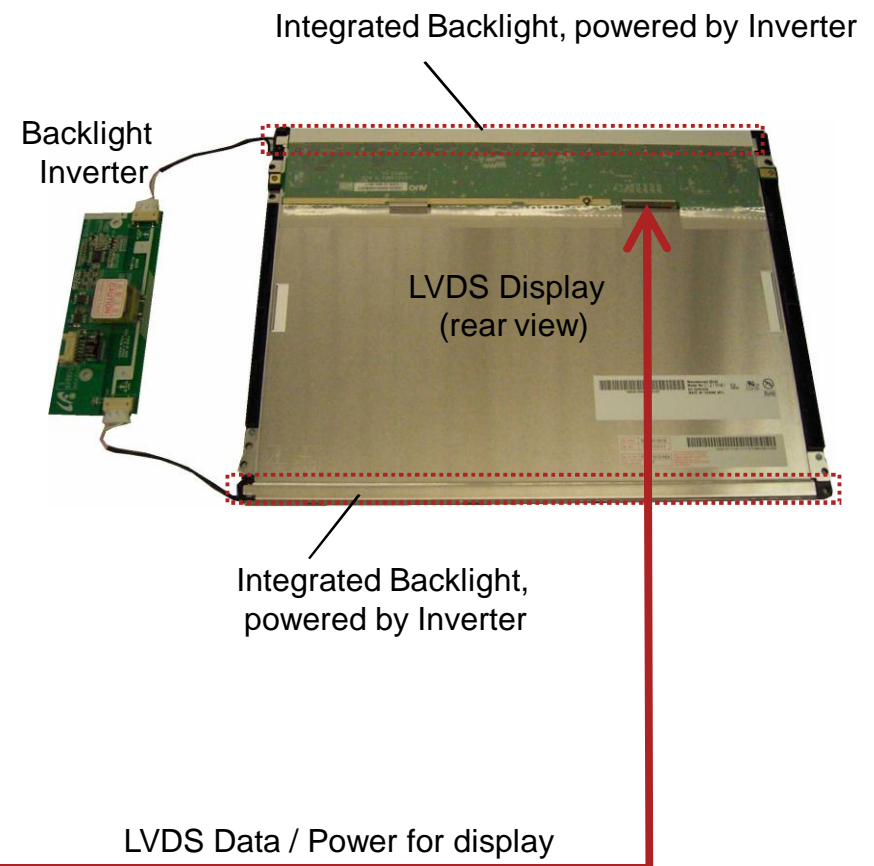
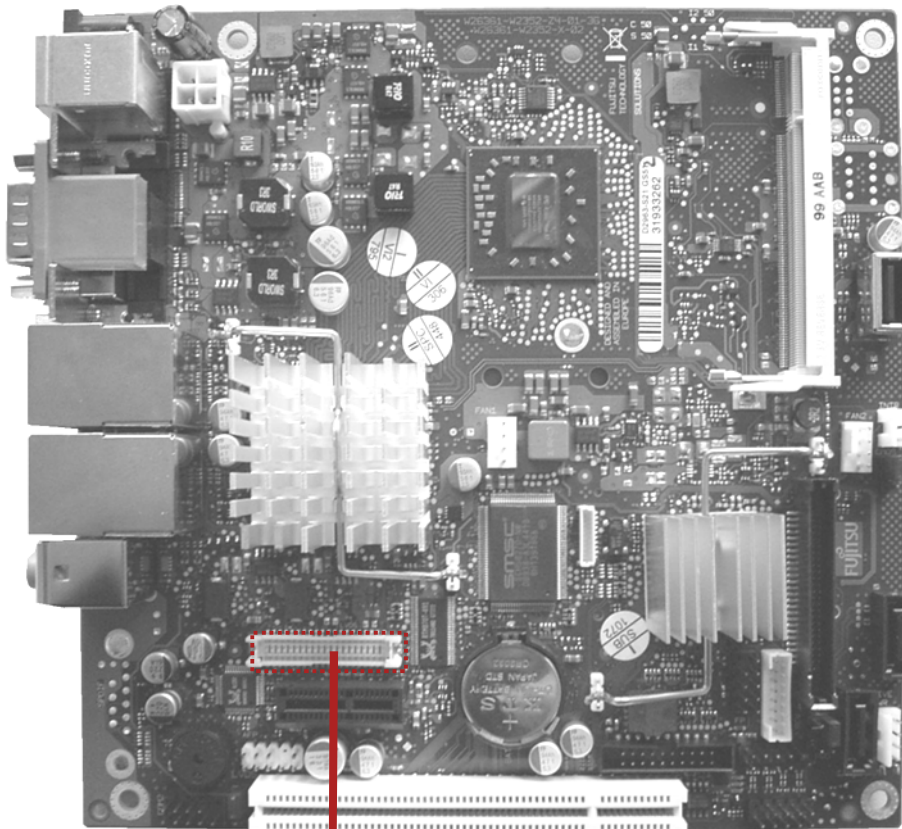

Display Options

LVDS Display & Backlight Inverter

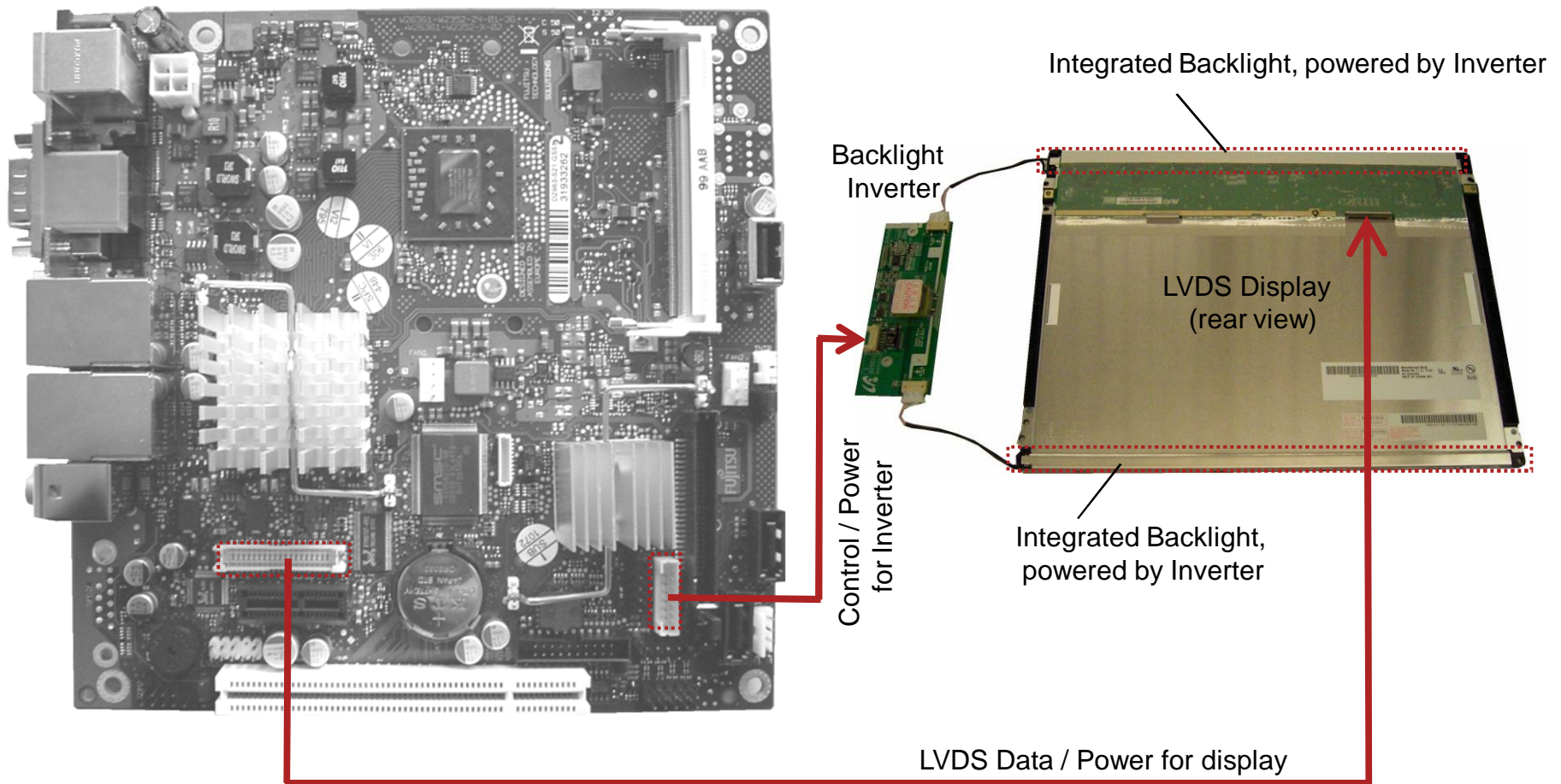

Display Options

LVDS Connector Details

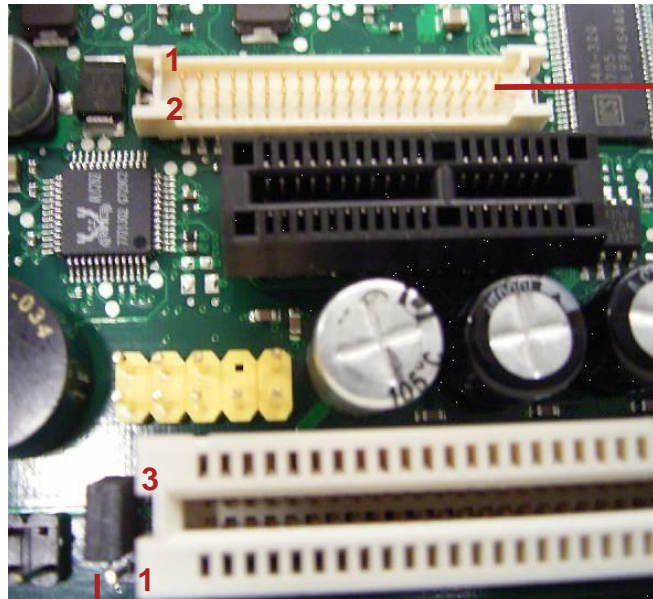

LVDS Connector: Hirose DF13-40 (or compatible)

LVDS voltage selector jumper

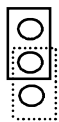

3.3V (default)
5V (optional)

Pin	Signal
3	VCC 3.3V
2	Power LVDS
1	VCC 5V

PIN	SIGNAL	SIGNAL	PIN
2	Ground	Ground	1
4	LVDS_H3+ (EVEN_3+)	LVDS_L3+ (ODD_3+)	3
6	LVDS_H3- (EVEN_3-)	LVDS_L3- (ODD_3-)	5
8	Ground	Ground	7
10	LVDS_H2+ (EVEN_2+)	LVDS_L2+ (ODD_2+)	9
12	LVDS_H2- (EVEN_2-)	LVDS_L2- (ODD_2-)	11
14	Ground	Ground	13
16	LVDS_H1+ (EVEN_1+)	LVDS_L1+ (ODD_1+)	15
18	LVDS_H1- (EVEN_1-)	LVDS_L1- (ODD_1-)	17
20	Ground	Ground	19
22	LVDS_H0+ (EVEN_0+)	LVDS_L0+ (ODD_0+)	21
24	LVDS_H0- (EVEN_0-)	LVDS_L0- (ODD_0-)	23
26	Ground	Ground	25
28	LVDS_CLK_H+ (CLK_EVEN+)	LVDS_CLK_L+ (CLK_ODD+)	27
30	LVDS_CLKH- (CLK_EVEN-)	LVDS_CLK_L- (CLK_ODD-)	29
32	Ground	Ground	31
34	DDC-Data	DDC-Clock	33
36	LCD-Power ¹⁾	LCD-Power ¹⁾	35
38	Ground	LCD-Power ¹⁾	37
40	LCD_Power_Enable	Ground	39

¹⁾ selectable via Jumper

max. load: 1A per pin!

Backlight Inverter Connector Details

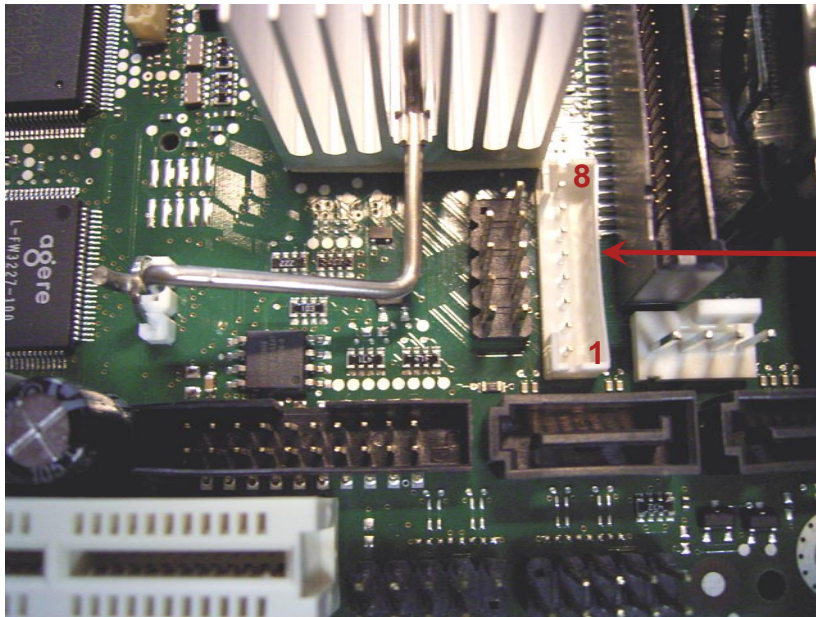

Backlight Inverter Connector: JST PHR-8

Ground	GND	1
Ground	GND	2
Backlight Brightness CTRL	tbd	3
Power 5V	VCC	4
Power 5V	VCC	5
Backlight On/Off Control	BL On/Off	6
Power 12V	+12V	7
Power 12V	+12V	8

max. load: 2A per pin!

Note:

Backlight Brightness Control: Provides a variable DC voltage between 0V and ~ 3.5V via an RC filter (2,2kOhm / 20uF). Basically the voltage level can be selected via *BIOS Setup – Peripheral Configuration – Brightness Control*. If this control signal is used, the system integrator is responsible for the implementation of a backlight converter that fits to the control output voltage range.

Backlight On/Off Control: Active High, 3.3V

Note: Polarity can be changed via BIOS Setup

(Not supported by pilot production mainboards GS5x!)

LVDS Timing & Screen Resolution

- Available default LVDS settings (BIOS Setup – Advanced – Peripheral Configuration)

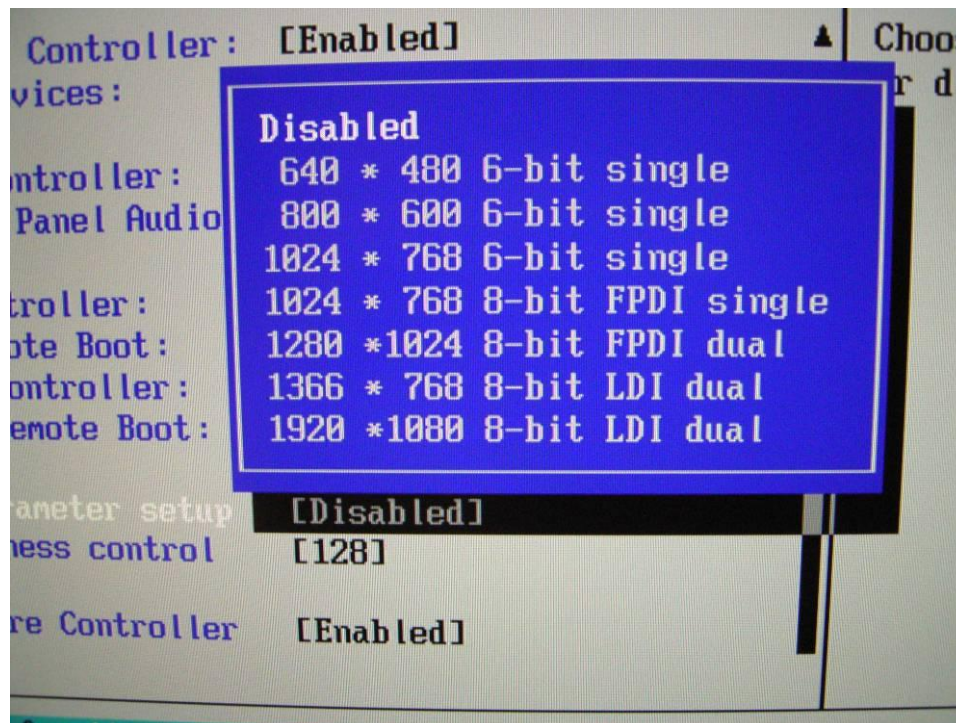

Detailed information (timing, pixels etc.) about each LVDS default setting is available in the related configuration files of the tool *LVDS.EXE* (see following page)

max. LVDS screen resolution:
2048 x 1536 / 32bit color

Note:

Default BIOS Setting for LVDS is "Disabled".

Any BIOS Setup changes can be fixed as new default BIOS setting via BIONVD tool!

<http://ftp.ts.fujitsu.com/pub/Mainboard-OEM-Sales/Services/Software&Tools/Common-Mainboard-Tools/ChangeBIOS-Setup-Defaults/>

LVDS Timing & Screen Resolution

- DOS-Tool LVDS.EXE V1.01 allows to adjust LVDS timing parameters

- Download link

ftp://ftp.ts.fujitsu.com/pub/Mainboard-OEM-Sales/Products/Mainboards/Industrial&ExtendedLifetime/D2963-S/IndustrialTools_D2963-S/LVDS-Tool/

- Select one of the seven default configuration files as master file
(Note: These default files are based on the seven BIOS Setup default LVDS settings)

- Rename selected file to *panel.txt*
- Edit file *panel.txt* according to required settings and save file
- Run following operation on target system (DOS-mode required!):
lvds -v -cf=panel.txt (= DOS Batch-File "Set-LVDS.bat")
- Change BIOS Setup
Advanced \ Peripheral Configuration
LCD Parameter setup --> *User Defined*
- Save settings and reboot system

- Note: In order to remove the "User defined" LVDS setting in BIOS Setup, run the DOS Batch-File "Remove.bat"



LVDS Cabling Reference

- Sample cabling diagrams for following LVDS displays & related inverters are available:

Display Size	TFT	Pixel	Inverter
10.4"	NEC NL6448BC33-63D	640 x 480	NEC 104PW201
12.1"	AUO G121SN01-V0	800 x 600	Green-C&C GH093A-ROHS
12.1"	LG-Philips LB121S03-TL01	800 x 600	Green-C&C GH001HB-ROHS
15"	Sharp LQ150X1LW71N	1024 x 768	TDK CXA-0349
15"	AUO G150XG01V0	1024 x 768	Green-C&C GH001A-ROHS
17"	AUO M170EG01-VD	1280 x 1024	Green-C&C GH053A-ROHS
19"	Sharp LQ190E1LW01	1280 x 1024	Power Systems PS-DA0412-05
19"	AUO M190EG01	1280 x 1024	GH053(A1)-ROHS



Display Options



LVDS Sample Cabling for AuO-G150

FSC D2703-S; Hirose DF13-40, straight, SMT LVDS-Connector			AUO-G150XG01; DF-14H-20P-1.25H (Hirose) or CWY20G-A0D1T (PTWO)	
SIGNAL	SYMBOL	PIN	Pin No.	Symbol
Ground	GND	1		
Ground	GND	2	20	GND
LVDS_Out3+ (ODD 3+)	LO3+	3	18	RzIN3+
LVDS_Out7+ (EVEN 3+)	LO7+	4		
LVDS_Out3- (ODD 3-)	LO3-	5	17	RzIN3-
LVDS_Out7- (EVEN 3-)	LO7-	6		
Ground	GND	7	3	GND
Ground	GND	8	4	GND
LVDS_Out2+ (ODD 2+)	LO2+	9	12	RzIN2+
LVDS_Out6+ (EVEN 2+)	LO6+	10		
LVDS_Out2- (ODD 2-)	LO2-	11	11	RzIN2-
LVDS_Out6- (EVEN 2-)	LO6-	12		
Ground	GND	13		
Ground	GND	14	7	GND
LVDS_Out1+ (ODD 1+)	LO1+	15	9	RzIN1+
LVDS_Out5+ (EVEN 1+)	LO5+	16		
LVDS_Out1- (ODD 1-)	LO1-	17	8	RzIN1-
LVDS_Out5- (EVEN 1-)	LO5-	18		
Ground	GND	19		
Ground	GND	20	10	GND
LVDS_Out0+ (ODD 0+)	LO0+	21	6	RzIN0+
LVDS_Out4+ (EVEN 0+)	LO4+	22		
LVDS_Out0- (ODD 0-)	LO0-	23	5	RzIN0-
LVDS_Out4- (EVEN 0-)	LO4-	24		
Ground	GND	25		
Ground	GND	26	13	GND
LVDS_CLK1+ (CLK ODD+)	CLK1+	27	15	CKIN+
LVDS_CLK2+ (CLK EVEN+)	CLK2+	28		
LVDS_CLK1- (CLK ODD-)	CLK1-	29	14	CKIN-
LVDS_CLK2- (CLK EVEN-)	CLK2-	30		
Ground	GND	31	16	GND
Ground	GND	32	19	GND
DDC-Clock	DDCCLK	33		
DDC-Data	DDCDATA	34		
LCD-Power ¹⁾	+3.3V / +5V	35	1	VDD
LCD-Power ¹⁾	+3.3V / +5V	36	2	VDD
LCD-Power ¹⁾	+3.3V / +5V	37		
Ground	GND	38		
Ground	GND	39		
LCD_PowerOn	LCD_On	40		

1) selectable via Jumper

Cable Length: 500mm

LVDS-Connector AuO_G150 based on Panel Datasheet

Pin No.	Symbol	Description
1	VDD	Power Supply, 3.3V (typical)
2	VDD	Power Supply, 3.3V (typical)
3	VSS	Ground
4	VSS	Ground
5	Rin0-	- LVDS differential data input (R0-R5, G0)
6	Rin0+	+ LVDS differential data input (R0-R5, G0)
7	VSS	Ground
8	Rin1-	- LVDS differential data input (G1-G5, B0-B1)
9	Rin1+	+ LVDS differential data input (G1-G5, B0-B1)
10	VSS	Ground
11	Rin2-	- LVDS differential data input (B2-B5, HS, VS, DE)
12	Rin2+	+ LVDS differential data input (B2-B5, HS, VS, DE)
13	VSS	Ground
14	CKIN-	- LVDS differential clock input
15	CKIN+	+ LVDS differential clock input
16	VSS	Ground
17	Rin3-	NC
18	Rin3+	NC
19	VSS	Ground
20	NC	Please "floating" and don't connect to ground.

LVDS-Extension für Philips LM150X08
LCD (CNI);DF14H-20P-1.25H (Hirose)

Pin No	Symbol
1	VLCD
2	VLCD
3	GND
4	GND
5	RXIN0-
6	RXIN0+
7	GND
8	RXIN1-
9	RXIN1+
10	GND
11	RXIN2-
12	RXIN2+
13	GND
14	RXCLK IN-
15	RXCLK IN+
16	GND
17	RXIN3-
18	RXIN3+
19	GND
20	GND

Symbol	Parameter	Min	Typ	Max	Unit	Condition
VDD	LCD Drive Voltage	3.0	3.3	3.6	[V]	
IDD	LCD Drive Current	-	1.0	1.3	[A]	VDD=3.3V, All Black Pattern
PDD	LCD Drive power consumption	-	3.3	4.3	[Watt]	VDD=3.3V, All Black Pattern
VDDns	Allowable LCD Drive Ripple Noise	-	-	100	[mV] P-P	

Display Options

DVI Output



Digital (DVI) Monitor

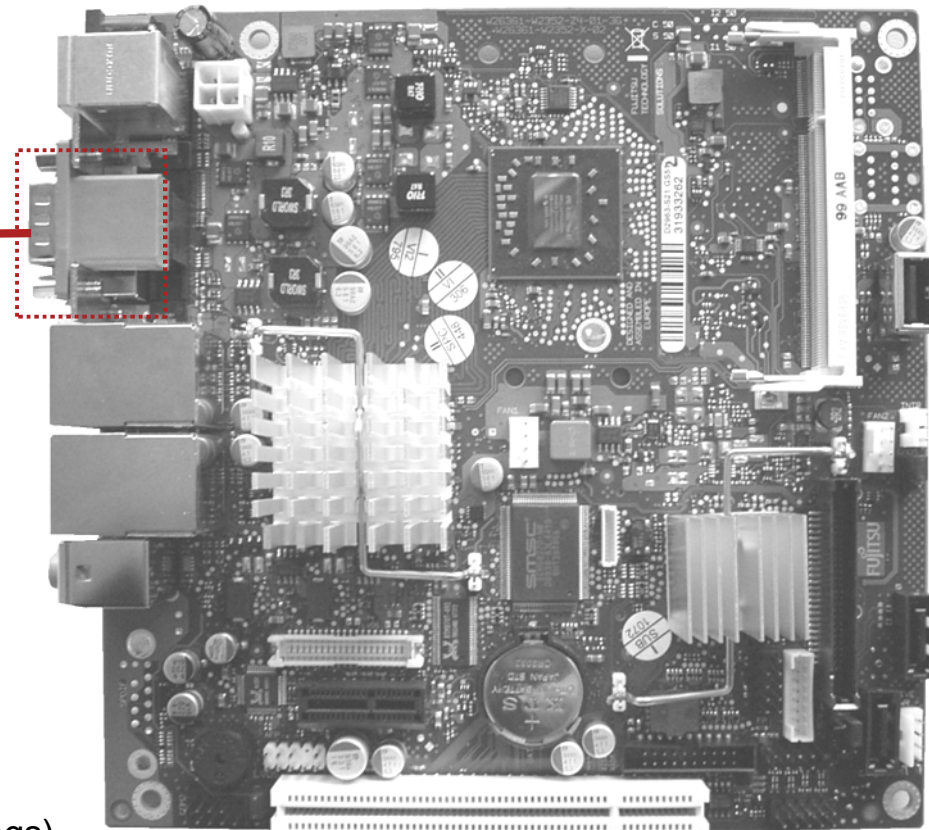

max. DVI screen resolution:
2560 x 1600 / 32bit color (Dual Link)
1600 x 1200 / 32bit color (Single Link, standard timings)
1920 x 1200 / 32bit color (Single Link, reduced blanking timings)

Display Options

HDMI Output (w/o audio!)

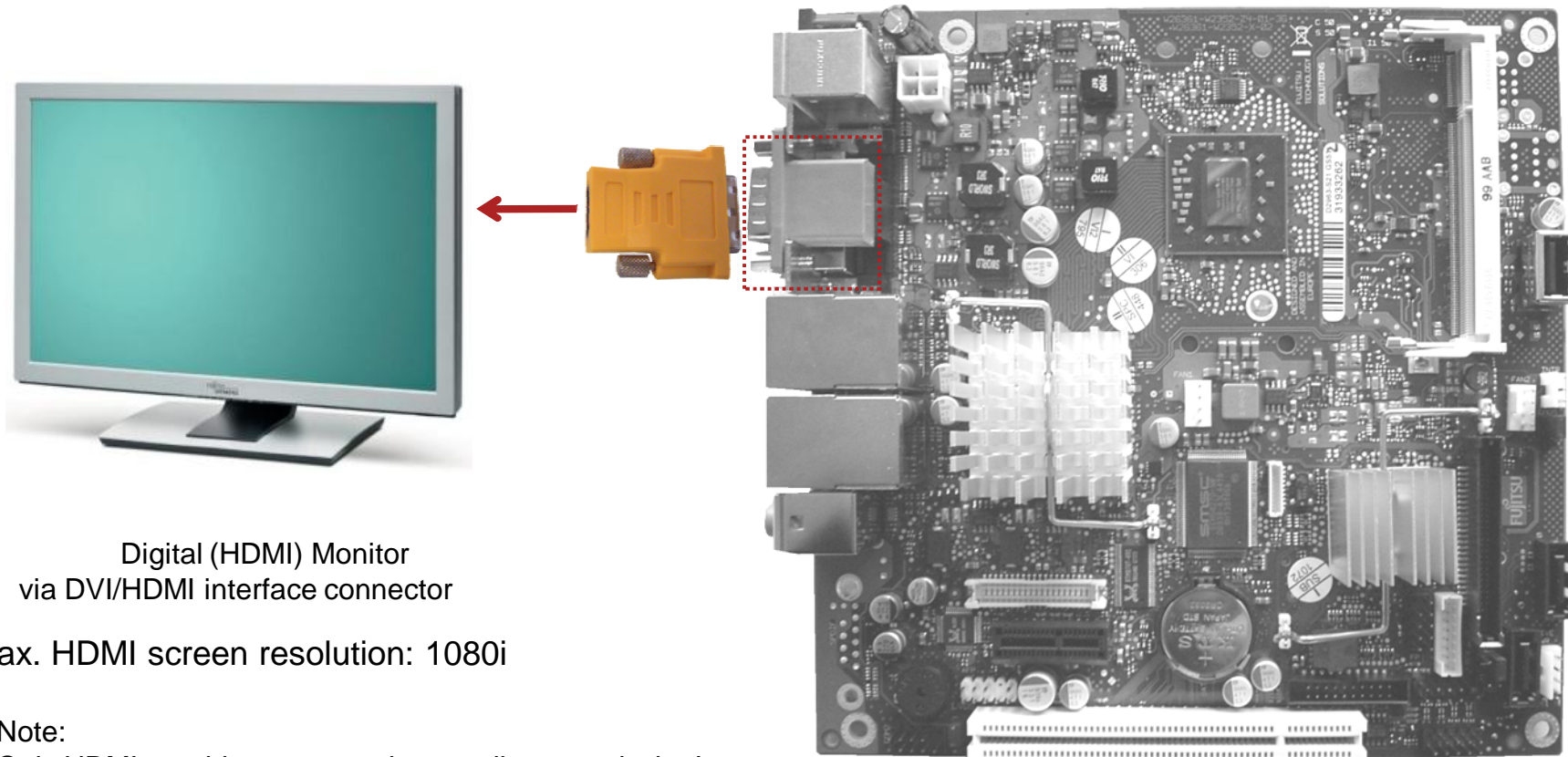

Digital (HDMI) Monitor
via DVI/HDMI interface connector

max. HDMI screen resolution: 1080i

Note:
Only HDMI graphics supported, no audio transmission!

Display Options

VGA Output via Interface Connector

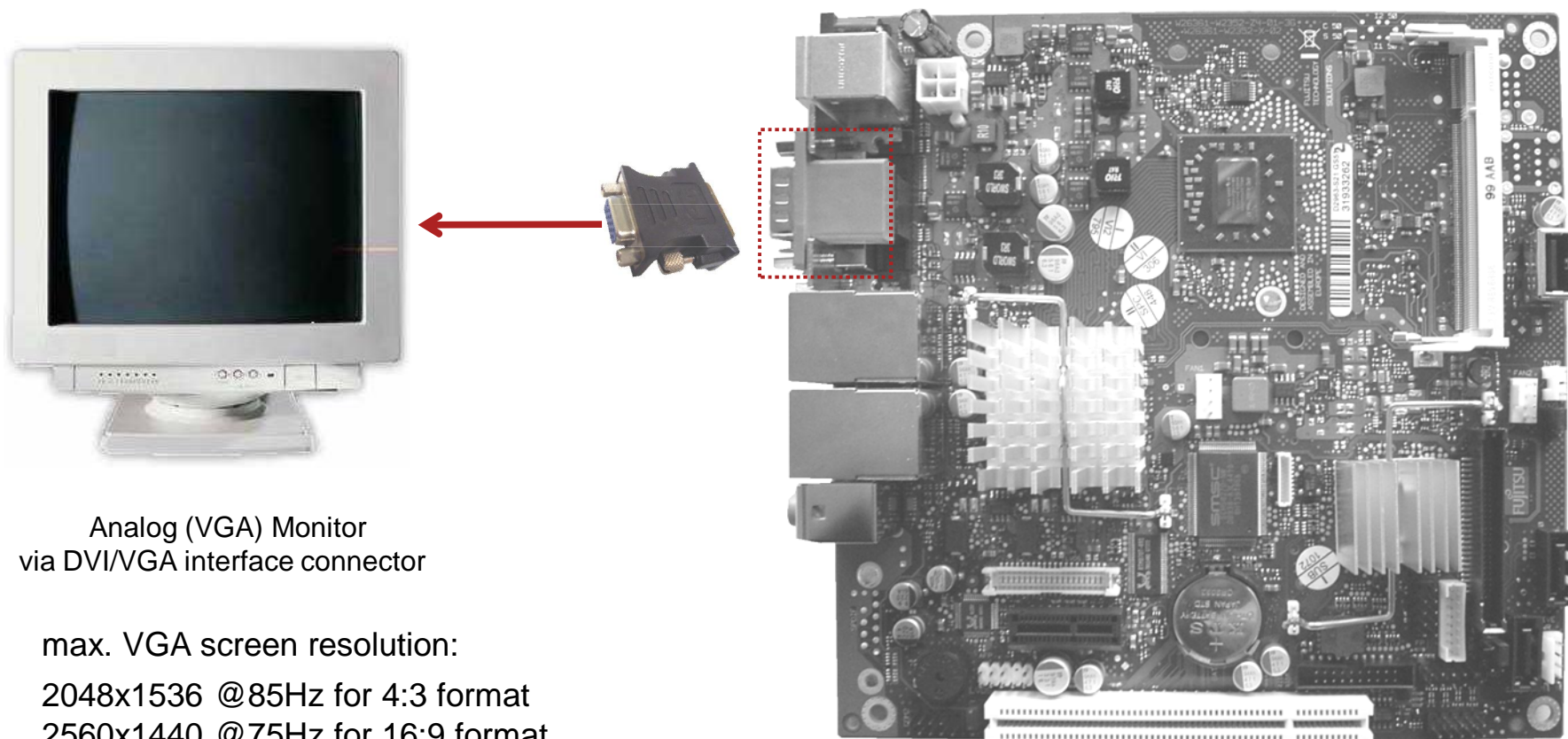

Analog (VGA) Monitor
via DVI/VGA interface connector

max. VGA screen resolution:
2048x1536 @85Hz for 4:3 format
2560x1440 @75Hz for 16:9 format
2456x1536 @60Hz for 16:10 format

Display Options

DVI & VGA via Splitter Cable

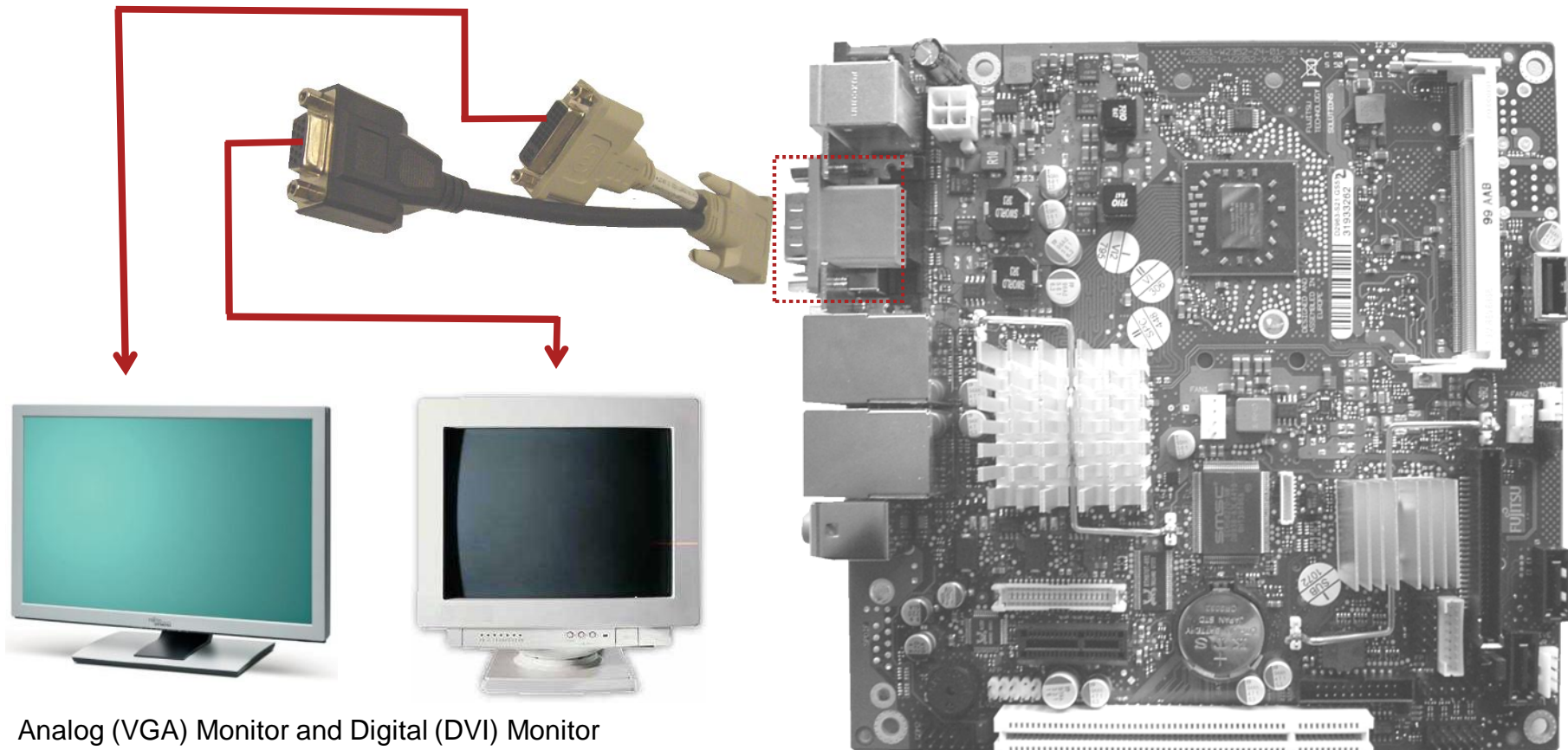

Analog (VGA) Monitor and Digital (DVI) Monitor
via DVI/VGA splitter cable

Dual Independent Display Option

(Note: DVI – single link only via splitter cable!)

Display Options

DVI or VGA plus LVDS

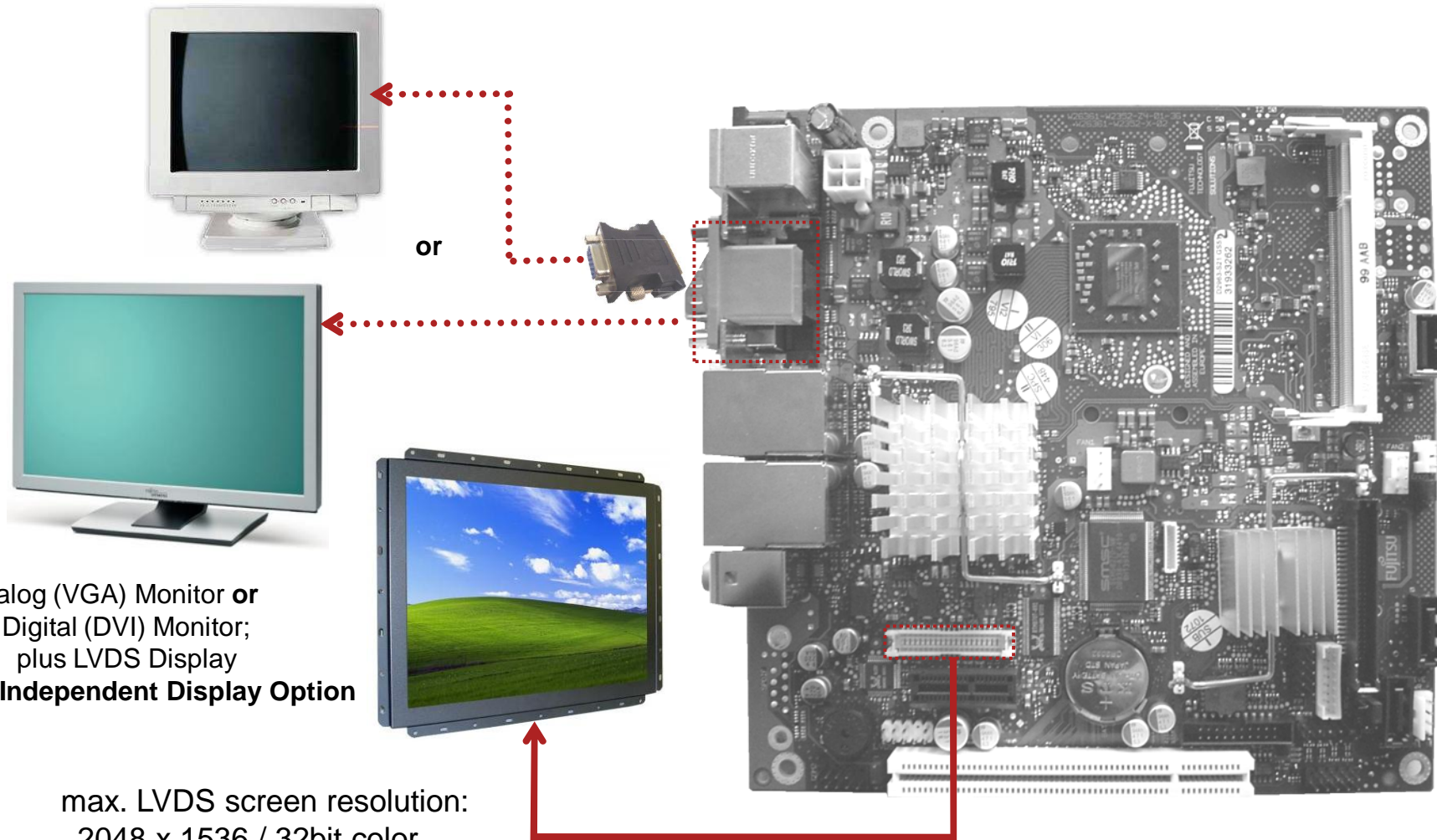

Power Supply Features

- 19-24V DC power supply
- Drive power connector

D2963-S offers two power supply options

1. Onboard 4 - pin power supply connector

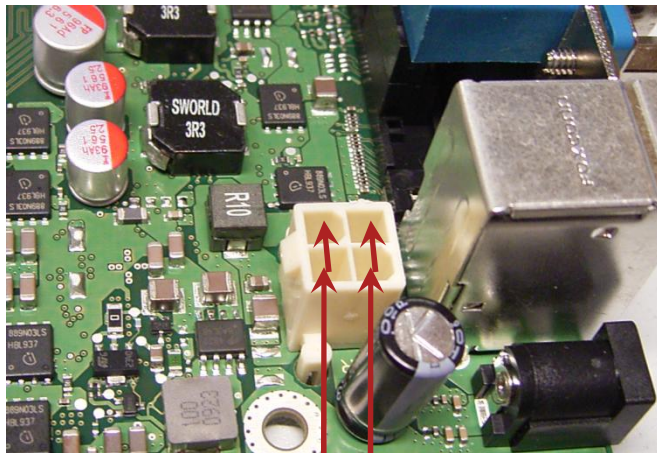

Pin 3, 4: +19...24V DC-In Pin 1, 2: GND

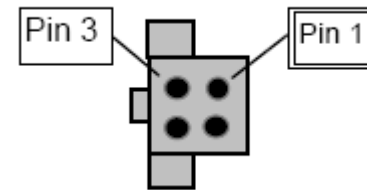

Pin 1, 2: GND
Pin 3, 4: +19...24V DC-In

2. External DC supply (AC adapter)

19...24V DC via external connector (AC adapter)

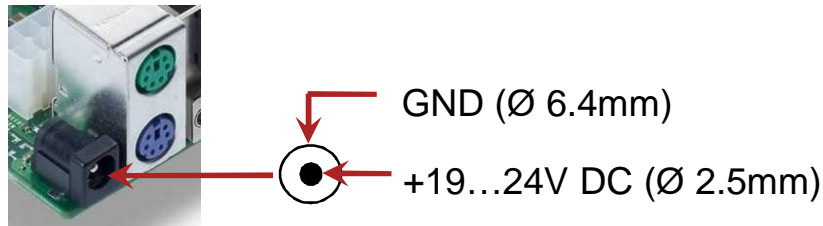

Appropriate DC plug for external AC adapter:



Ø 2.5mm / 5.5mm

contact length ~ 10-11mm

Angle plug or straight plug

Note: "Universal Plug" not allowed due to possible polarity mismatch!

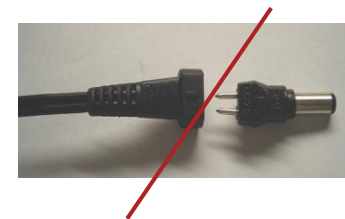

Requirements for 19-24V operation

Nominal operating range 19 - 24V
Max. operating range (19V -15%) - (24V +10%)
Ripple / noise max. 400mV (PP)
Max. input current: 5A

The DC power supply input provides a capacitive load of 700 μ F which has to be covered by the AC adapter respectively the DC source during power ramp-up.

Mainboard output current:

The max. mainboard output power available via PCI/PCIe- connector, USB-connectors, GPI/O, backlight-connector, and drive power connector is limited!

Max. overall output current:

+3.3V / 5A

+5V / 4.5A

+12V / 2.5A

-12V / 0.1A

See mainboard specification for further details!



Power Supply Features



Power option for internal drives

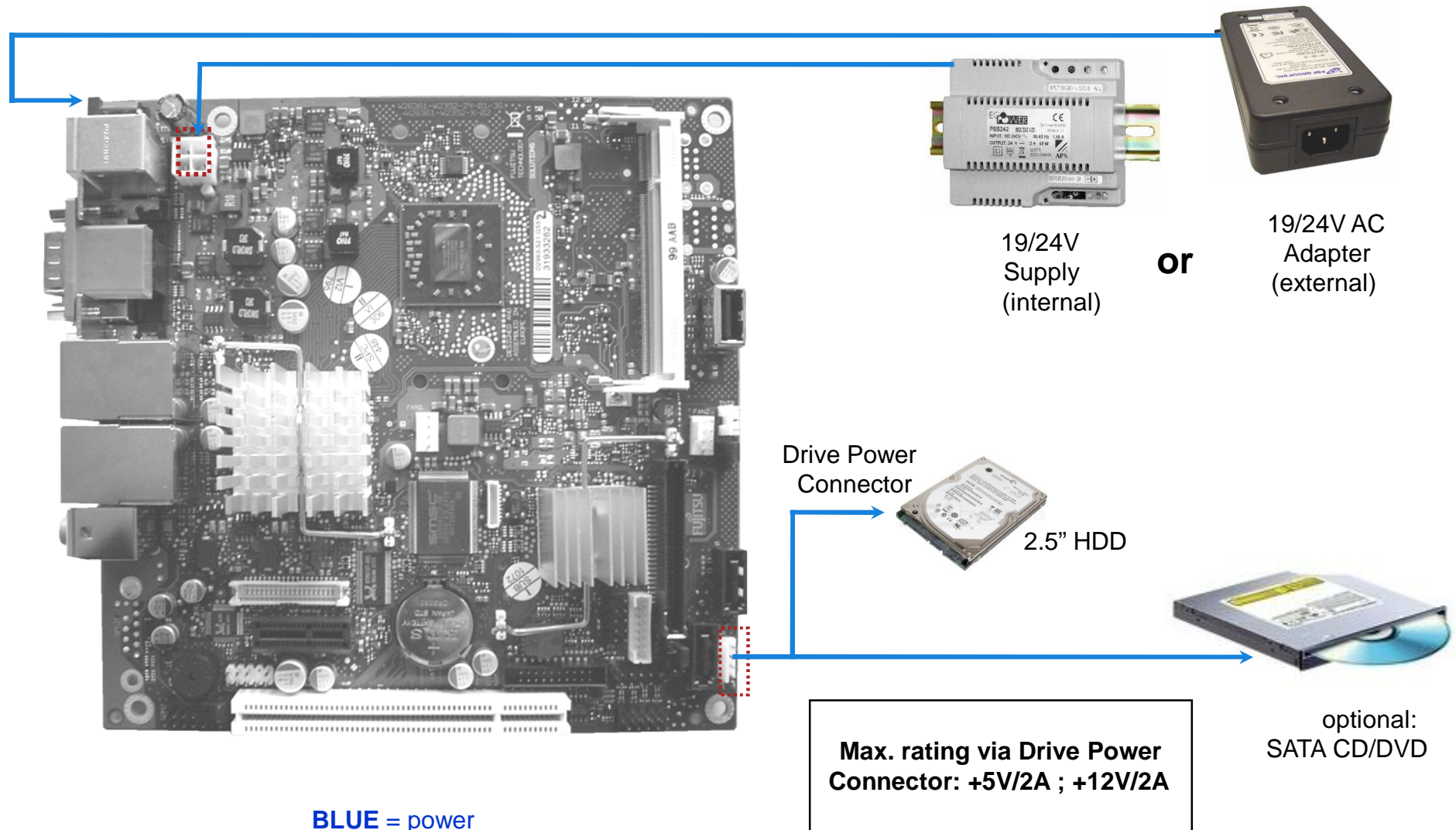

Power Supply Features



Power option for internal drives

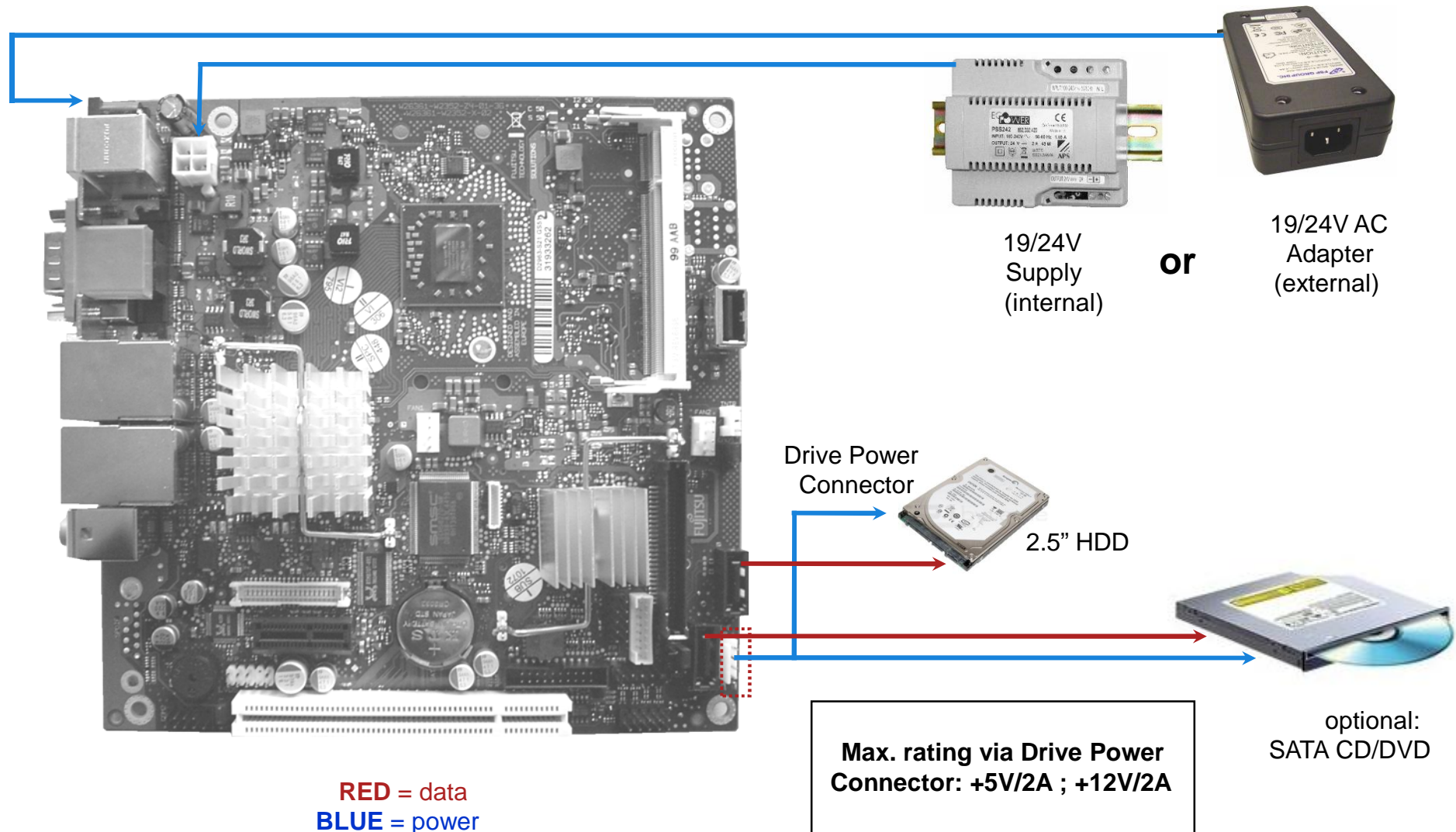

Drive Power Connector

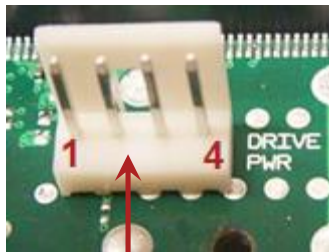

Drive Power Connector

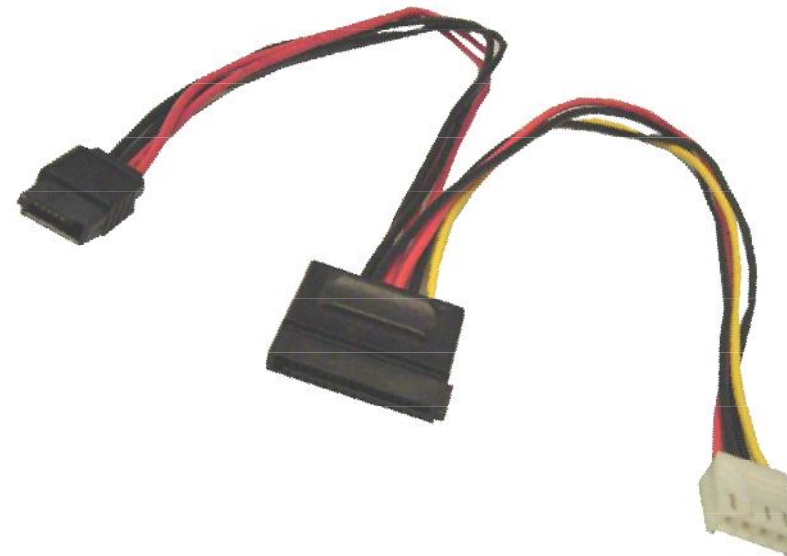

1	VCC (+5V)	max. 2A
2	GND	
3	GND	
4	+12V	max. 2A

Note:
Connector is compliant to standard floppy power supply connector.

Power Supply Features

Fujitsu DrivePowerCable

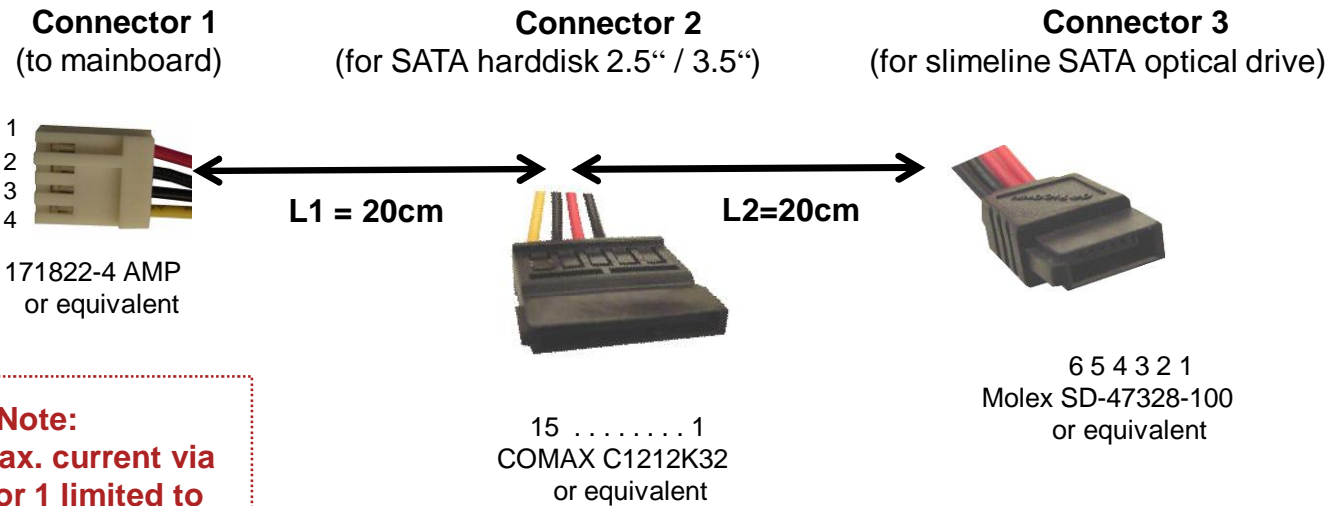

Note:
overall max. current via
connector 1 limited to
+5V / 2A and
+12V / 2A

connector pinning			
Conn. 1	Conn. 2	Conn. 3	Note
1	7, 8, 9	2, 3	+5V, red
2	4, 5, 6	5, 6	GND, black
3	10, 11, 12		GND, black
4	13, 14, 15		+12V, yellow



Cable Ordercode:
T26139-Y1500-V700

Additional Power Output via Inverter Connector

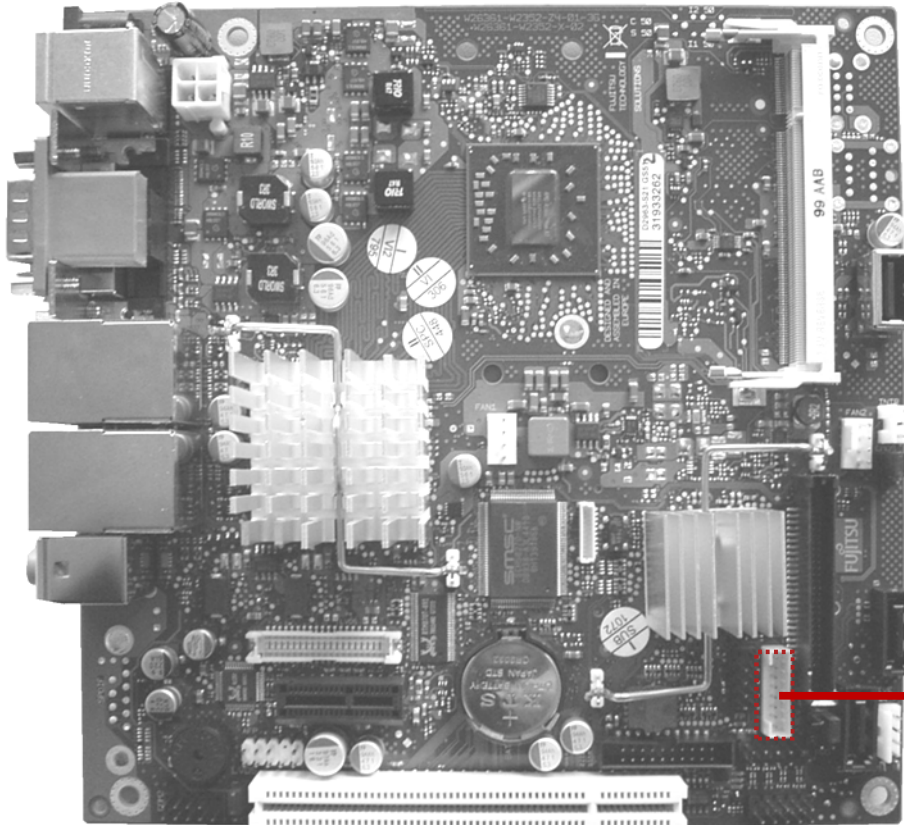

Prerequisite: No LVDS display attached to mainboard!



The backlight inverter connector provides additional power for internal devices (+5V / +12V; max. 2A per pin!)

Power Supply Features

Additional Power Output via Feature Connector

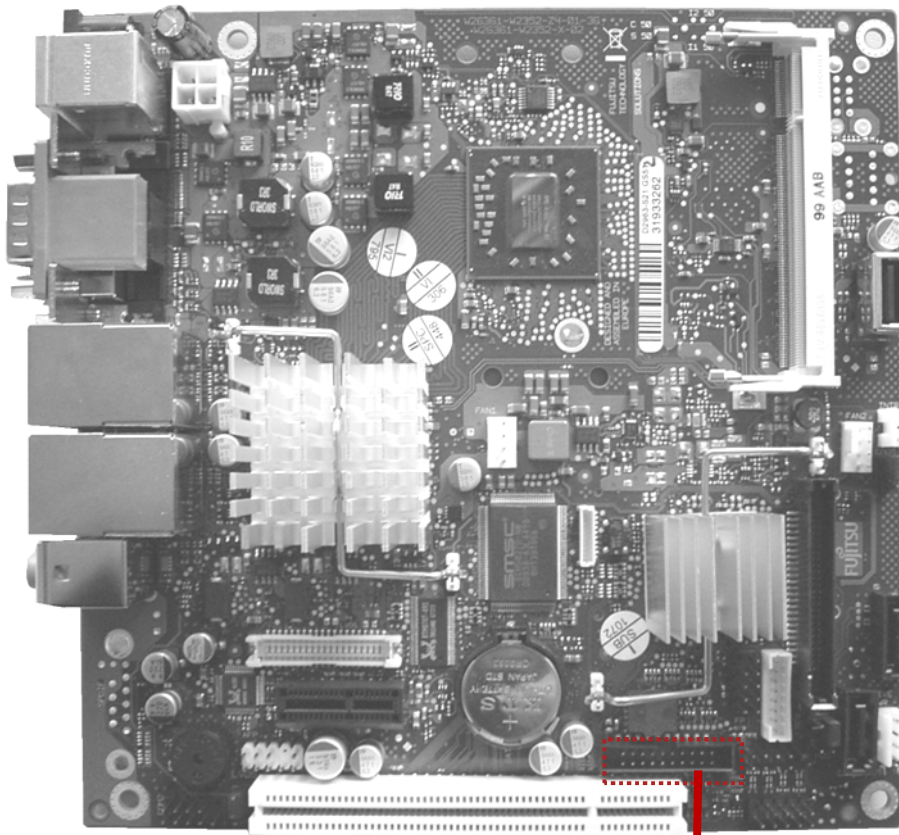

Feature Connector



Feature Connector provides additional power for internal devices:

- 3.3V
- 5V
- 12V
- 5Vaux

max. 1.5 A per pin!

Internal Connectors

- Optional Devices via Feature Connector
- Internal USB/Audio Ports
- Compact Flash
- Second Serial Port
- Frontpanel Connector
- PCI / PCIe / Mini-PCIe Extension Slot

Optional Devices via Feature Connector

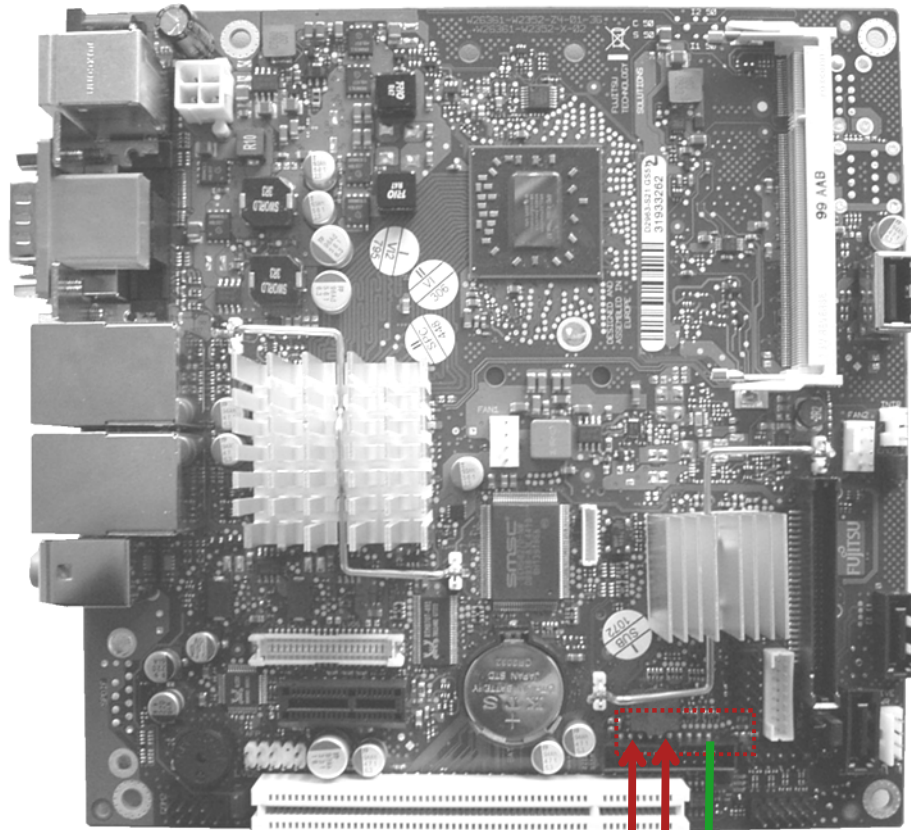

Feature Connector



8 bit 3.3V General Purpose Input/Output (GPIO) in order to attach any digital device (sample picture)

Feature Connector provides additional power for internal devices (3.3V; 5V; 12V; 5Vaux; max. 1A per pin!)



IrDA Transceiver (sample picture)

Feature Connector Details

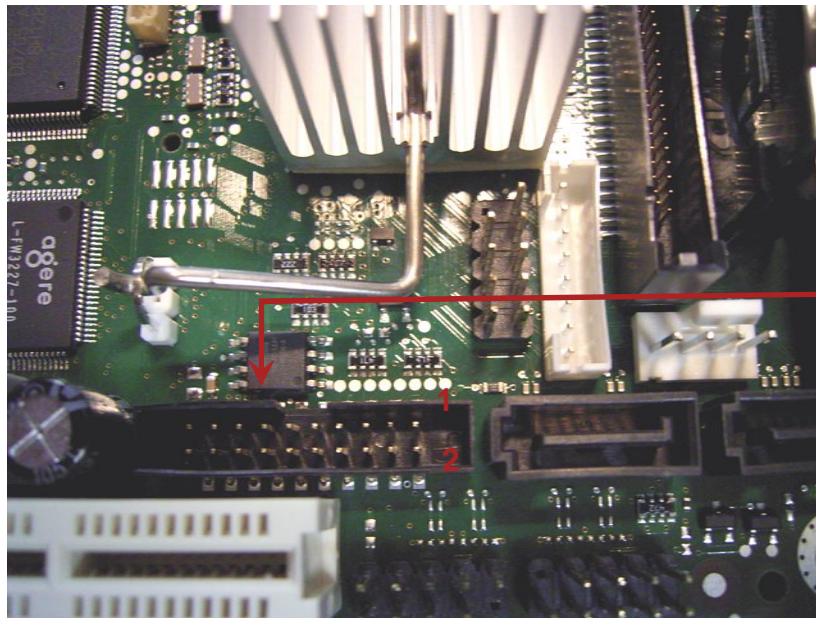

Feature Connector: CompuPack R-DRK2-20-S3-SMT

1	GPI/O_0	GPI/O_1	2
3	GPI/O_2	GPI/O_3	4
5	GPI/O_4	GPI/O_5	6
7	GPI/O_6	GPI/O_7	8
9	VCC_3.3V	GND	10
11	VCC_3.3V	VCC_5Vaux	12
13	IrDA_Tx	GND	14
15	IrDA_Rx	GND	16
17	GND	VCC_5V	18
19	VCC_12V	VCC_12V	20

Note: Current max. 1.5 A per power pin!

Notes:

- SW-access to GPI/O: see mainboard specification for details
- **A Windows-based API is available for easy implementation of the GPIO features (included in SystemMonitoring API)**
Available via OEM FTP Server:

ftp://ftp.ts.fujitsu.com/pub/Mainboard-OEM-Sales/Products/Mainboards/Industrial&ExtendedLifetime/D2963-S/IndustrialTools_D2963-S/BMC_Management-Controller-API/

Parameter	Range
GPI/O Input Low Voltage	-0.5V ... 1.3V
GPI/O Input High Voltage	1.8V ... VCC_3.3V
GPI/O Output Low Voltage	max. 0.4V
GPI/O Output High Voltage	min. 2.4V
Input Leakage Current	max. +/- 10µA
Note: max. load per GPI/O pin: 8mA	

Internal Connectors

Internal USB/Audio Ports

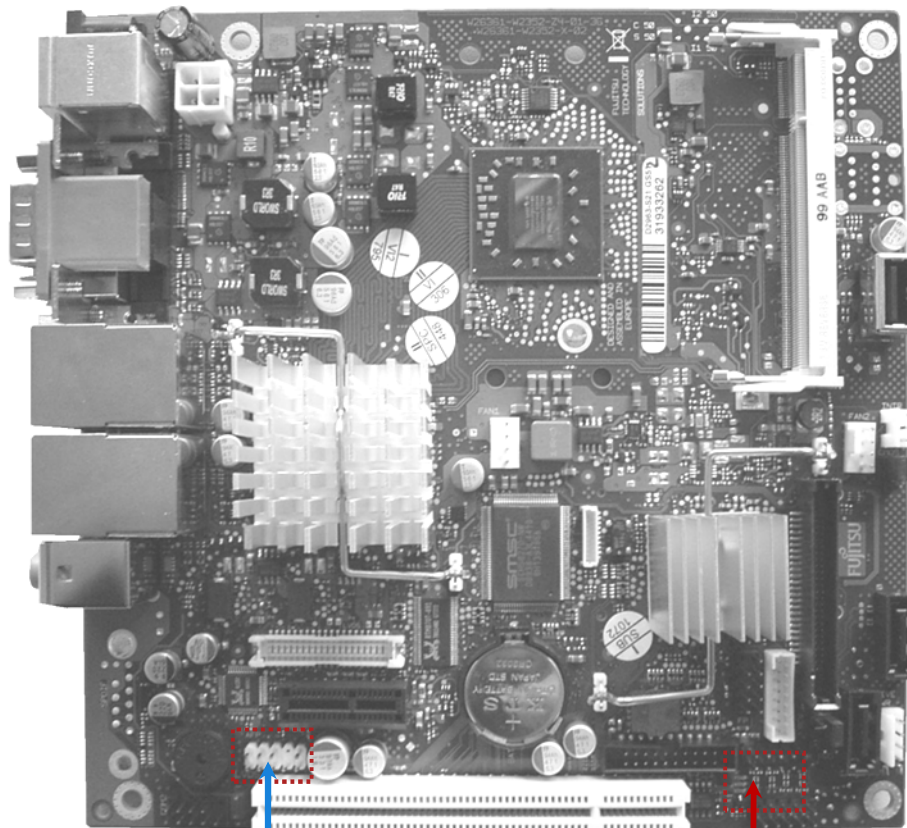

RED = USB
BLUE = Audio

Frontpanel
Audio

USB Ports



Connect internal ports to USB/
Audio frontpanel module
(Note: 2 USB ports per connector)

Internal USB Ports – Miscellaneous Options

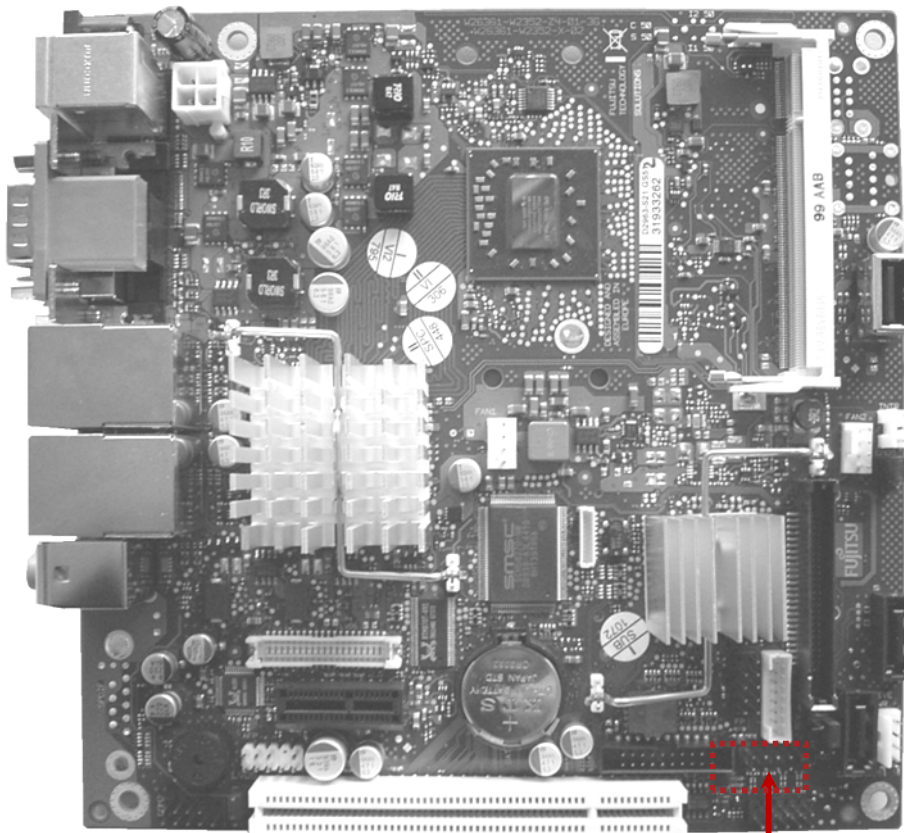

USB Ports



Optional: Touchscreen
Controller via USB

Internal USB Ports – Miscellaneous Options

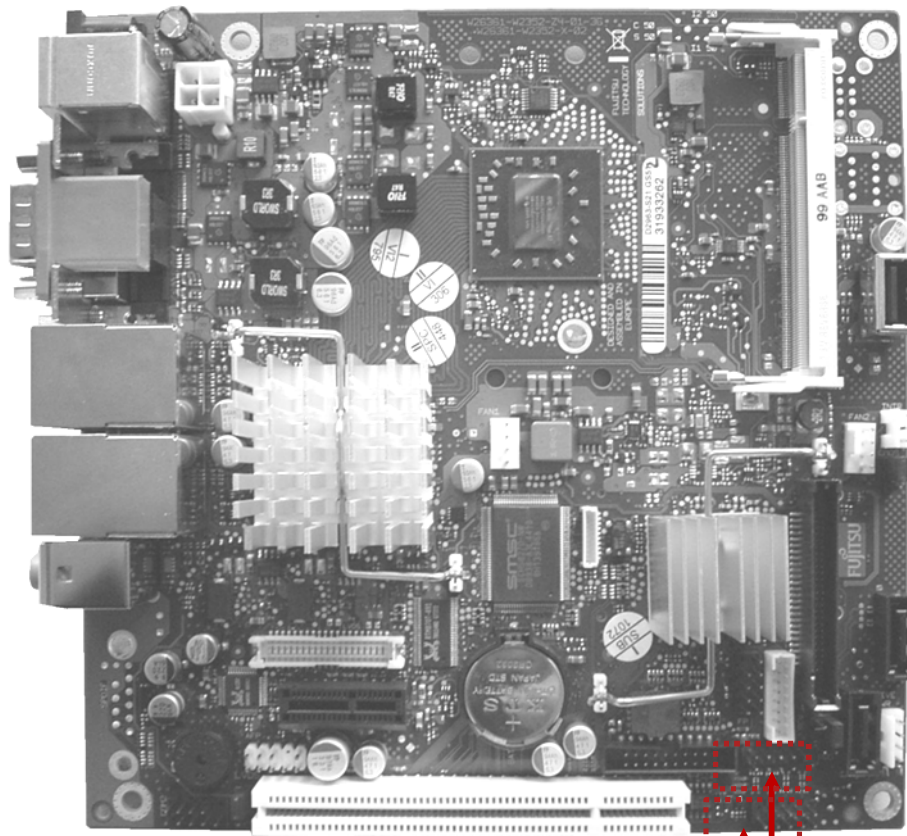

USB Ports



Optional: Touchscreen
Controller via USB



Optional: Attach USB
Flash Disk Module
(up to 8GB available)
e.g. www.stec-inc.com

Compact Flash

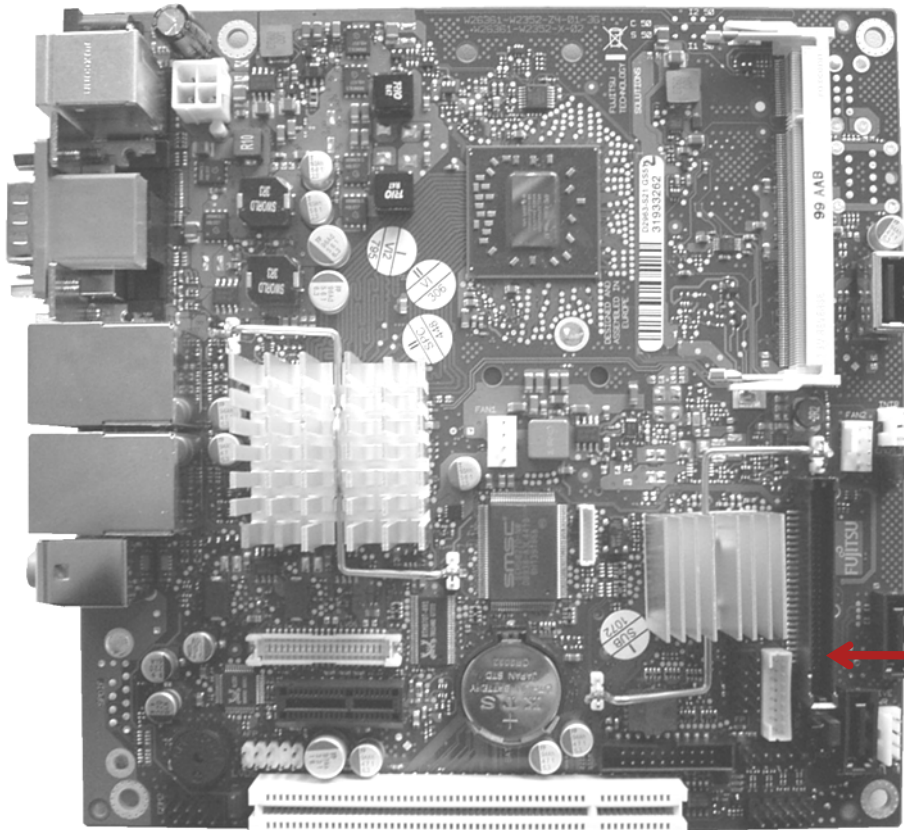

CF Card – inserted in socket on mainboard (IDE „Master“-Interface)

Second Serial Port

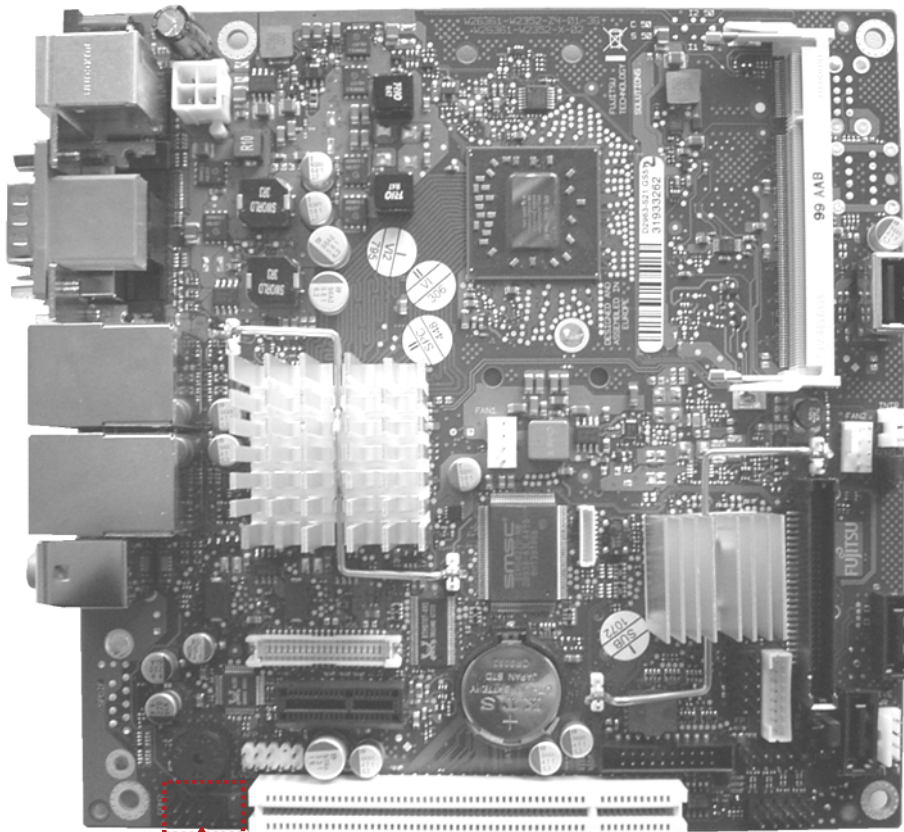

COM2
Connector

Pin	Signal
1	DCD 2
2	DSR 2
3	SIN 2
4	RTS 2
5	SOUT 2

Pin	Signal
6	CTS 2
7	DTR 2
8	RI 2
9	GND

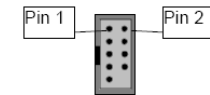

Note: Pinning according FTS standard!

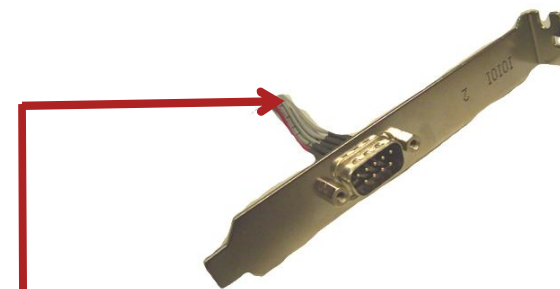

External I/O Bracket

Frontpanel Connector

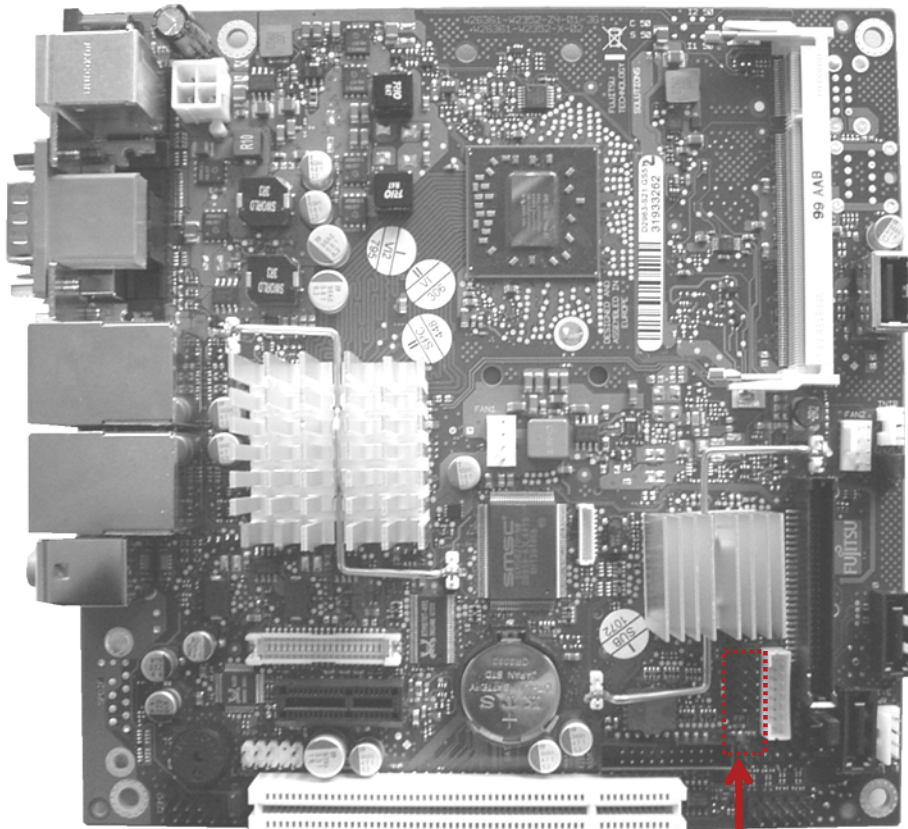

Frontpanel
Connector



- Frontpanel providing
- Powerswitch
 - Power/HDD-LED
 - Reset-Switch

Frontpanel Connector Details

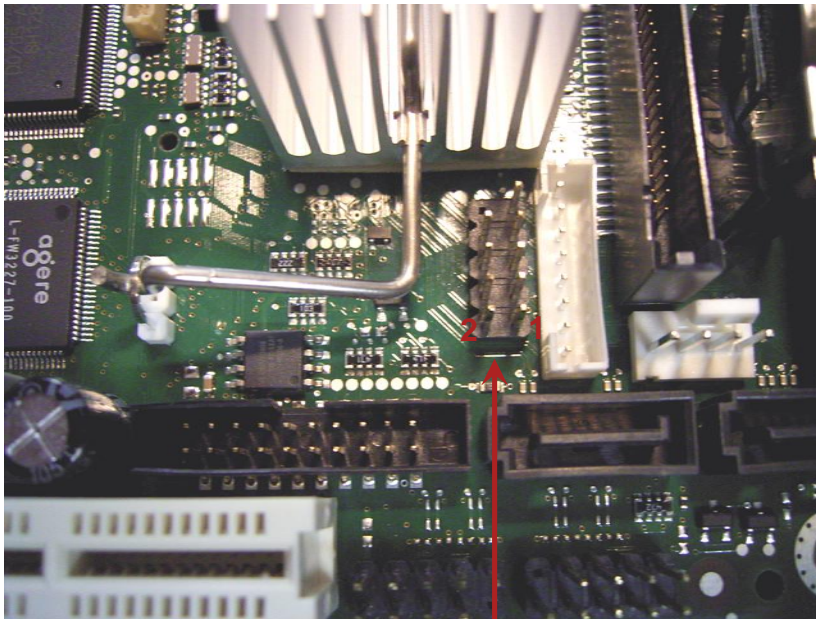

Frontpanel Connector

Power LED: 3.3V supply
max. 10mA
onboard 100R series resistor

HDD LED: 5.0V supply
max. 10mA
onboard 330R series resistor

10	(KEY)	Reserved (NC)	9
8	PowerSwitch_GND	ResetSwitch_P	7
6	PowerSwitch_P	ResetSwitch_GND	5
4	Power_LED_GND	HDD_LED-	3
2	Power_LED+	HDD_LED+	1

Note: Pinning is compatible to Intel 10 pin header

PCI Extension Slot

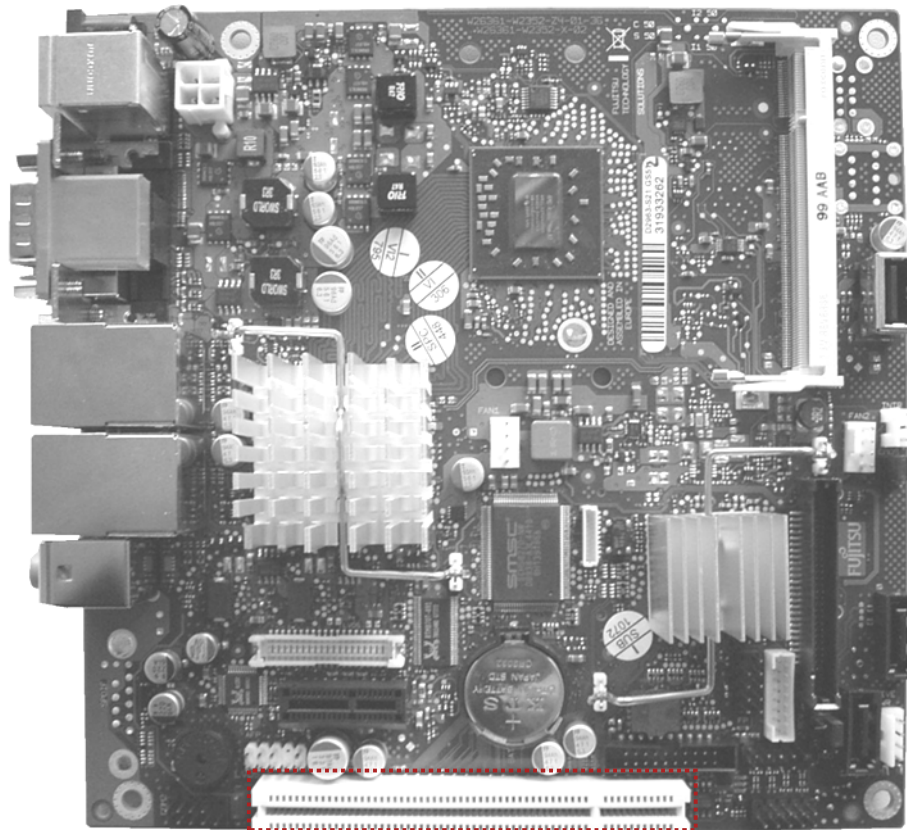

- 32Bit, 33MHz, PCI Rev. 2.3
- Compliant to 3.3V / 5V devices
- Supports up to two PCI master slots via risercards

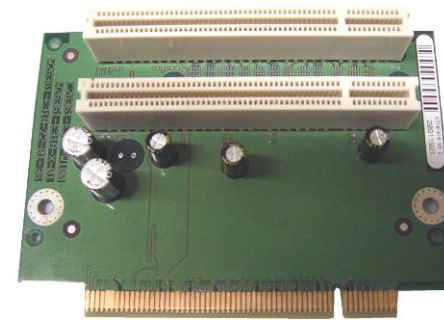

PCI Riscards offered by FTS

Note: Third party risercards must not use any "Reserved"-pins of PCI connector!

PCI Express Extension Slot

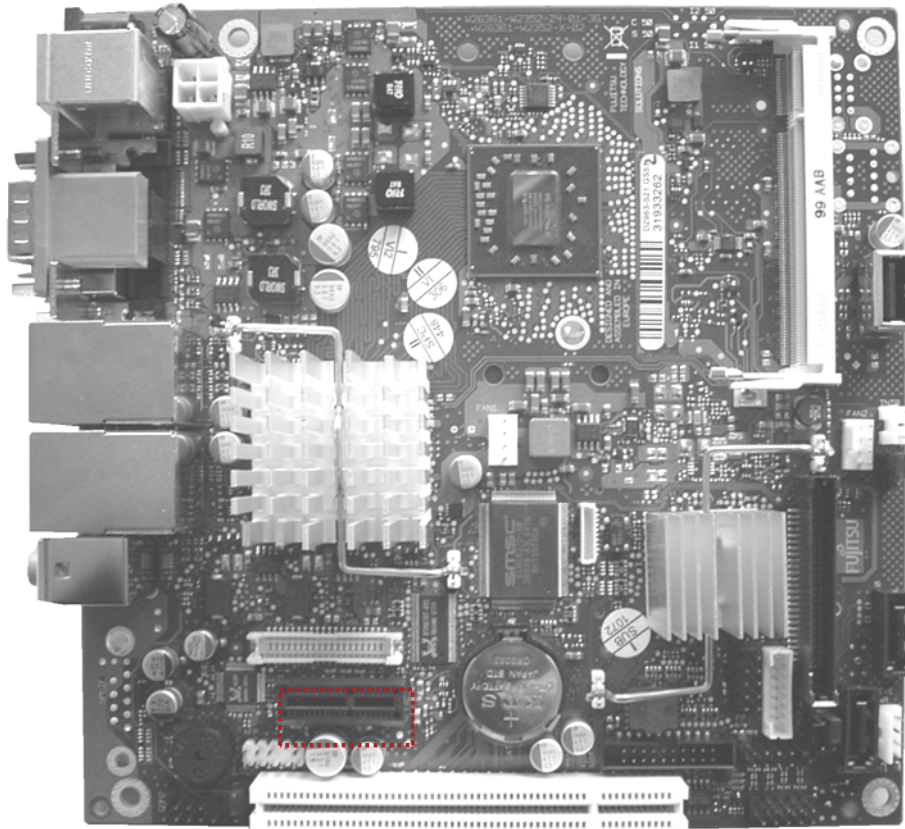

- PCIe x1

- Provides the option to install customer-specific extension cards
- Note: External connectors of PCIe x1 cards require appropriate aperture in chassis rear!

Mini PCI Express Extension Slot (bottom side)

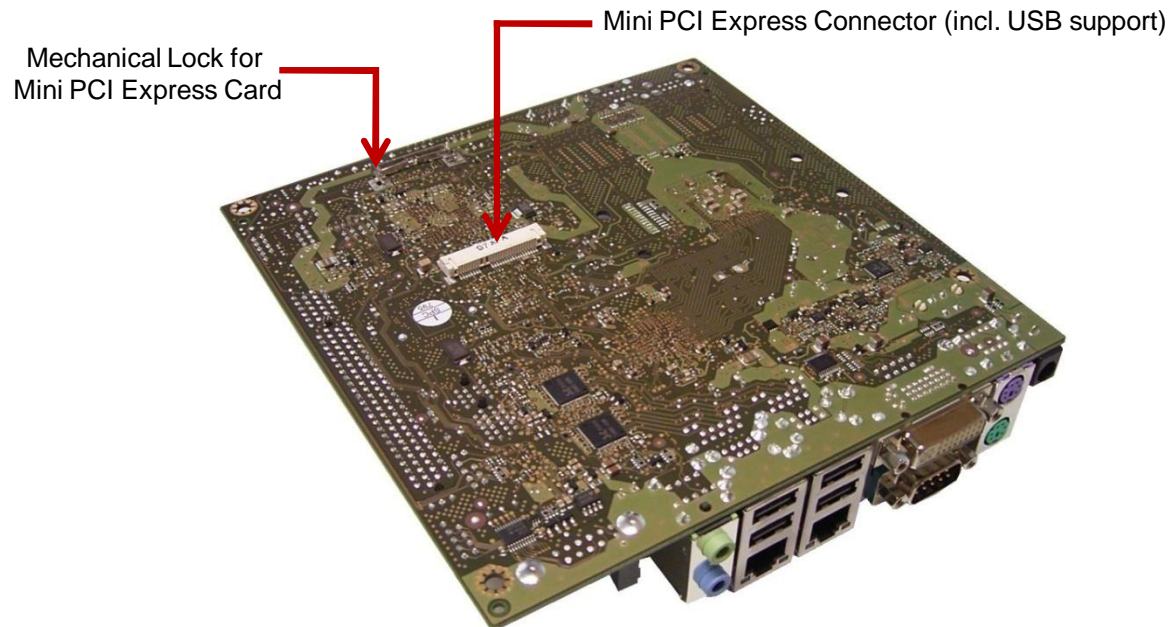

Note:
Mini card lock supports full length cards only!

System Monitoring

- Temperature Sensors and Fans
- SystemGuard: Fan/Temperature Monitor
- SilentFanConfig: Customize System Monitoring
- Temperature Reference Points

D2963-S: Fans

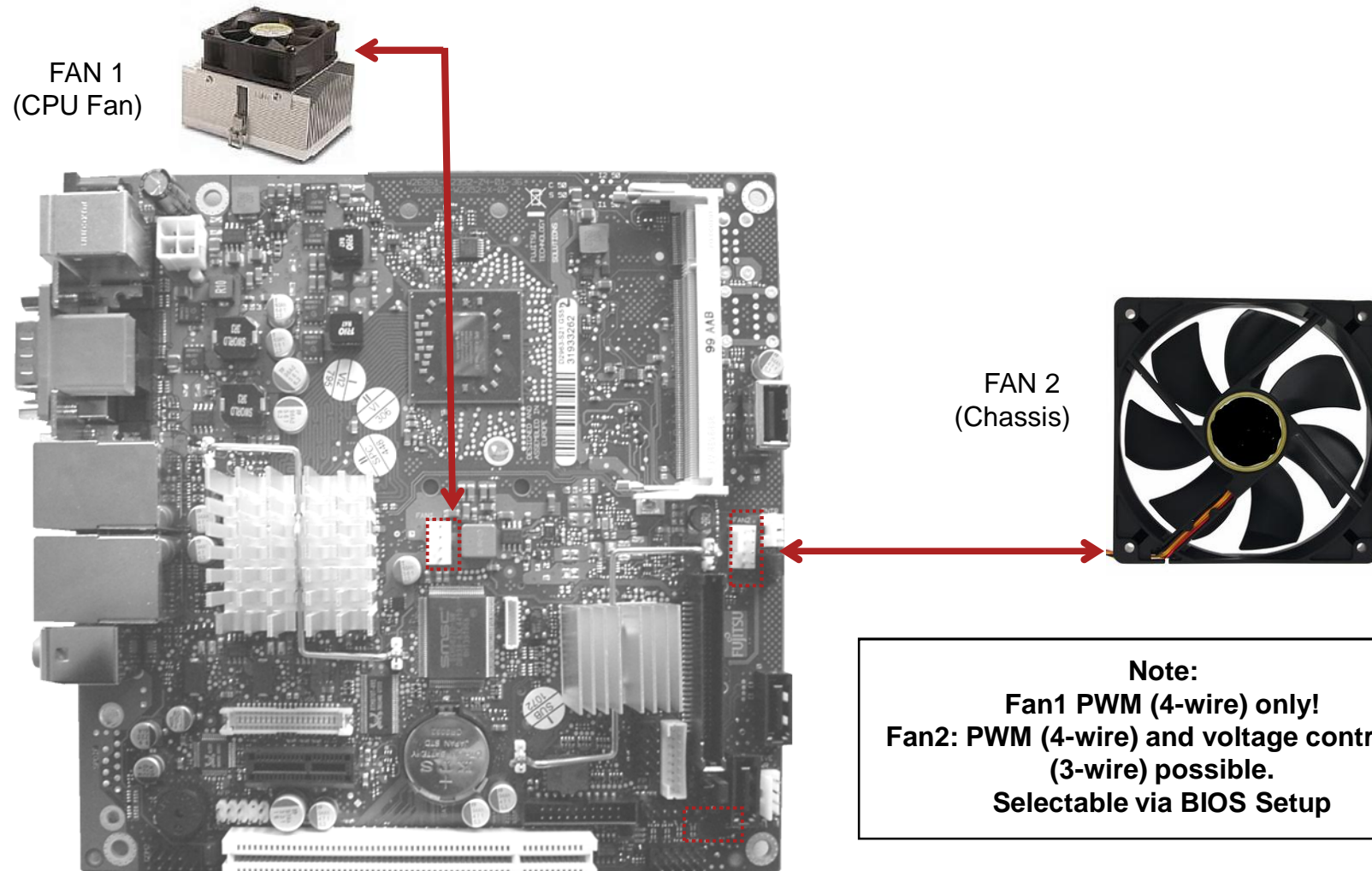

Note: Do not attach more than one fan per connector!

D2963-S: Temperature Sensors

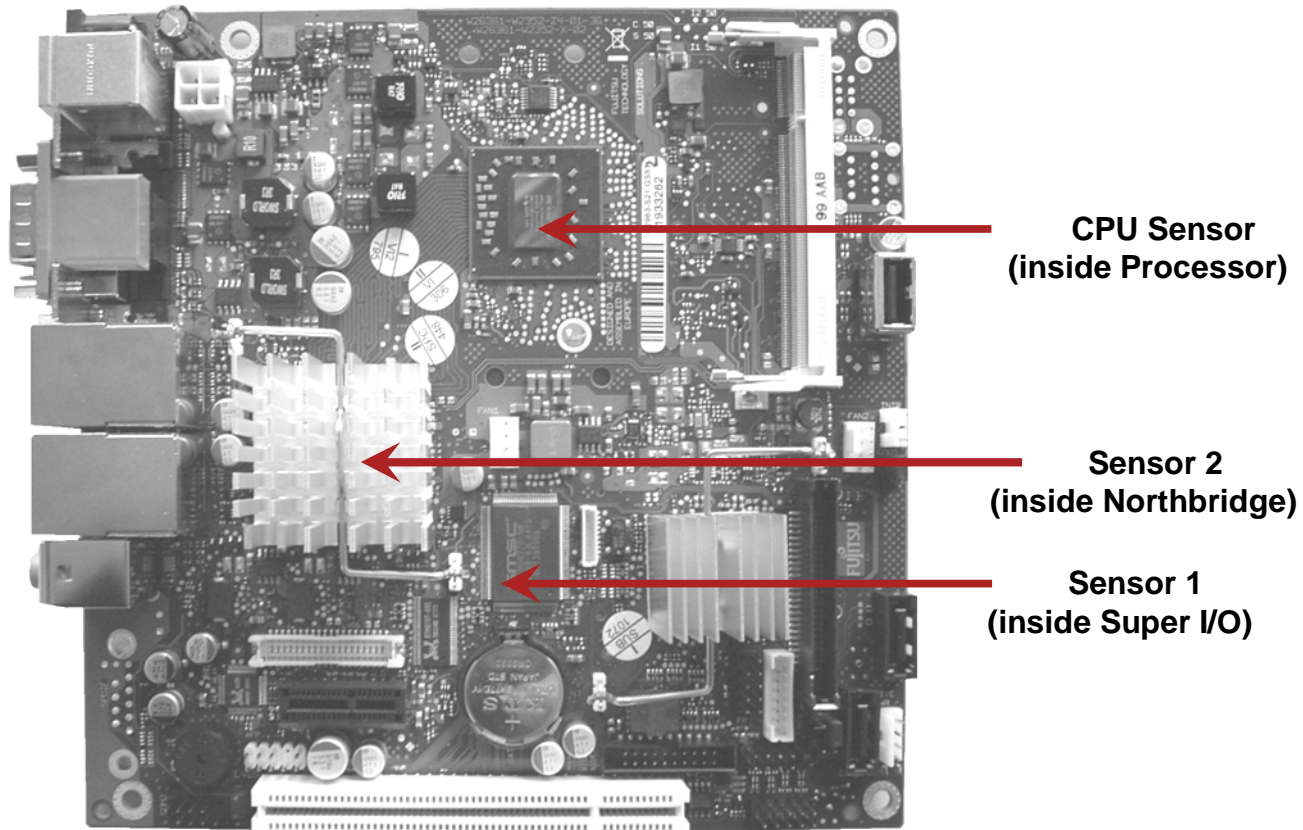

D2963-S: BIOS Fan Settings

BIOS Setup option for Fan2
Note: Default setting is PWM (4-Wire)

Setting "3-Wire":
The default minimum operating voltage is set to ~ 6V; the maximum operating voltage (full speed) is 12V.

Note:
If a 3-wire fan is used while BIOS Setup is set to "4-Wire", the fan will operate at full speed (=12V operating voltage)!

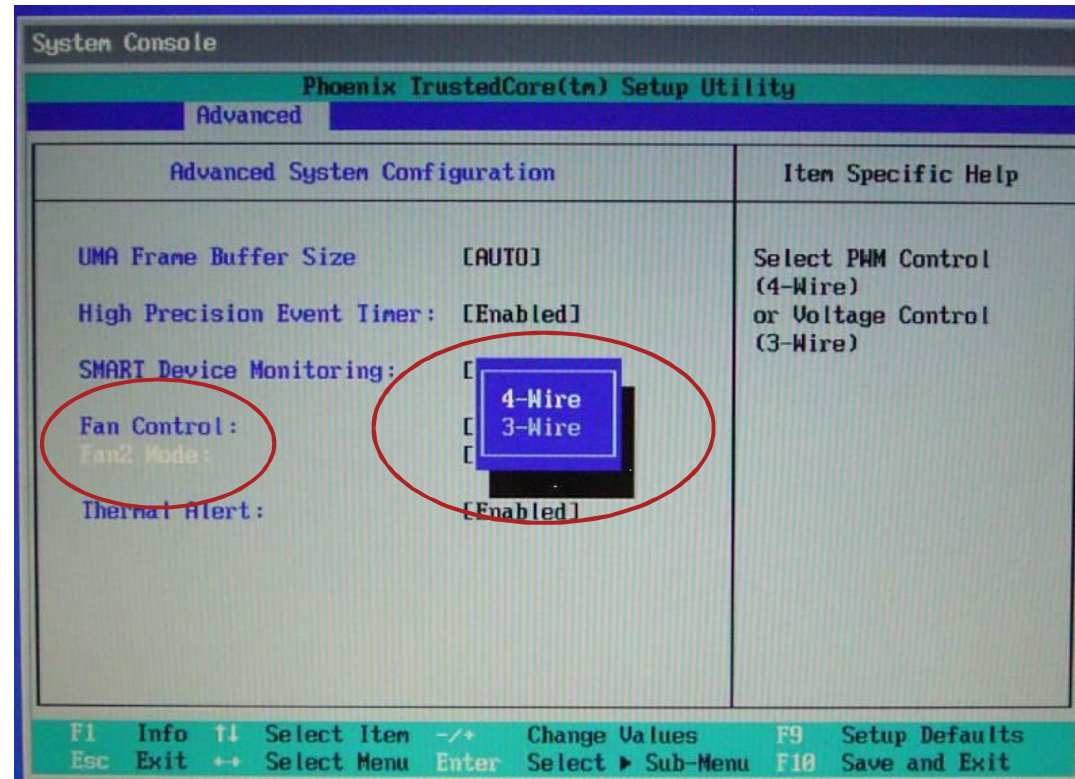

SystemGuard: Fan/Temperature Monitor

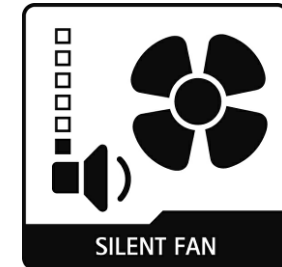

- **Windows-based Monitoring Tool**

- Download link to latest version:

<ftp://ftp.ts.fujitsu.com/pub/Mainboard-OEM-Sales/Services/Software&Tools/Common-Mainboard-Tools/SystemGuard/>

Note:

Version 3.50 or higher recommended for D2963-S

- SystemGuard offers several options like “LogFile- feature” and “No Adjustments- mode”
Details are available here:

<ftp://ftp.ts.fujitsu.com/pub/Mainboard-OEM-Sales/Services/Software&Tools/Common-Mainboard-Tools/SystemGuard/Documentation/>

- Note: A Windows-based API is available for easy implementation of the
System Monitoring features like fan speed, sensor temperatures etc.

ftp://ftp.ts.fujitsu.com/pub/Mainboard-OEM-Sales/Products/Mainboards/Industrial&ExtendedLifetime/D2963-S/IndustrialTools_D2963-S/BMC_Management-Controller-API/

D2963-S: SystemGuard

Temperature Sensors

Northbridge Sensor

Super I/O Sensor

Processor Sensor

Sensor / Fan Matrix

Factory default setting:

- FAN1 (CPU) controlled by Processor temperature ¹⁾
- FAN2 controlled by all sensors

Current Fan Speed

1) Note: Characteristics for FAN1 is always dependent on CPU temperature – fully controlled by the system BIOS. Due to safety reasons this influence cannot be disabled!

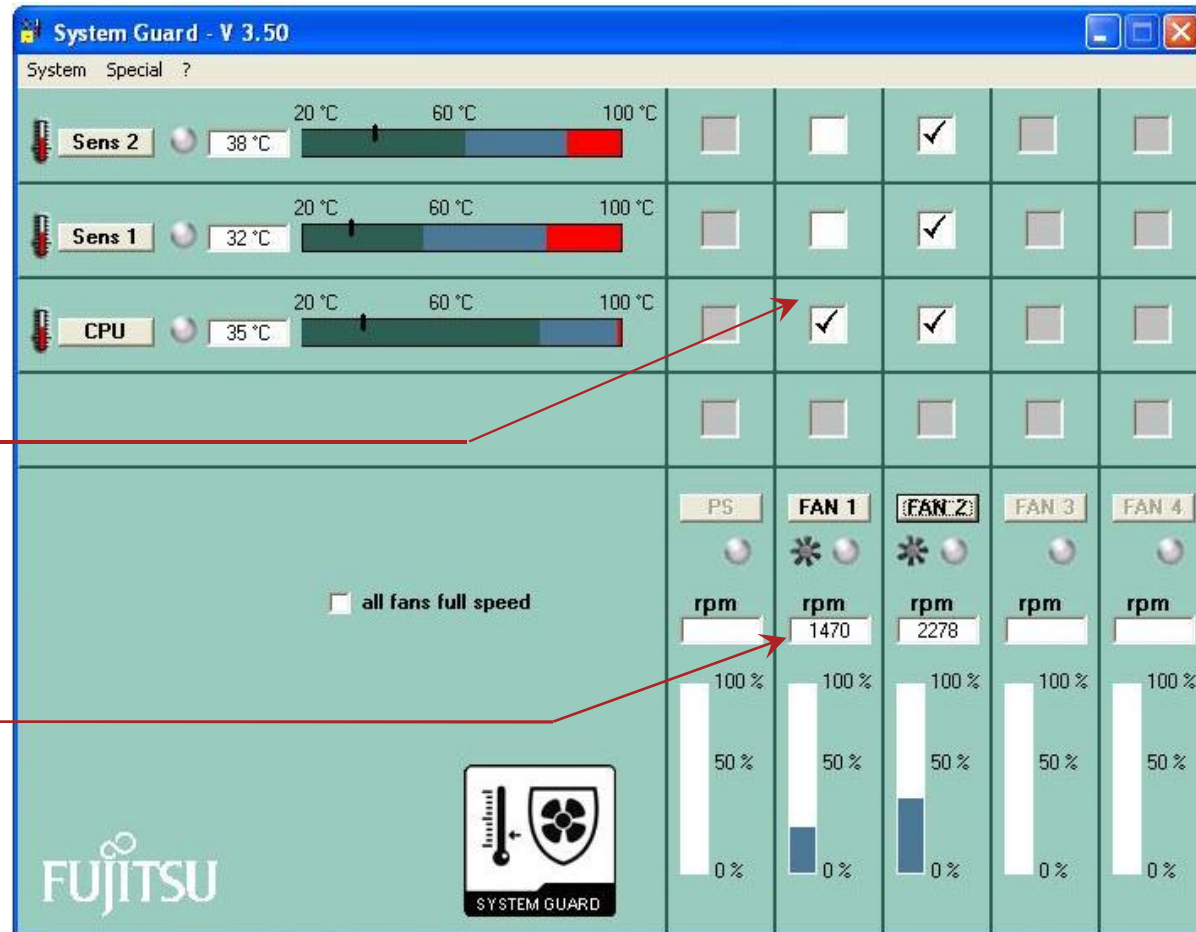

All relevant System Monitoring parameters can be customized via SilentFanConfig-Tool!

SystemGuard – Sample for Customized Fan Settings

Temperature Range for Sens1 adjusted

Minimum fan speed within “green” range;
fan speed increases within “blue” range

Sensor / Fan Matrix

Only Sensor 1 (Super I/O) controls Fan2

Current Fan Speed

Min. fan speed (fan2) reduced

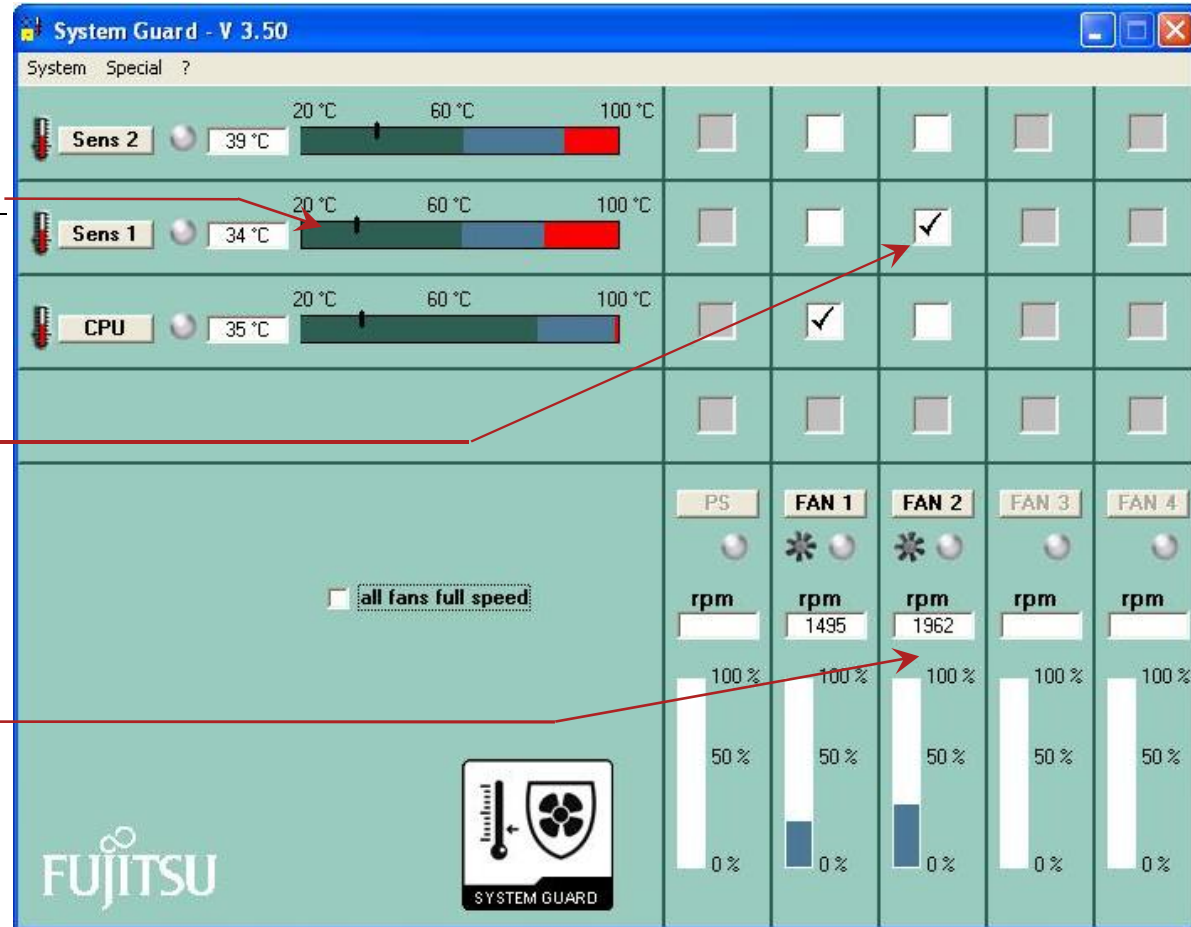

Note: This specific setting is recommended if D2963-S is installed in the Fujitsu Industrial Mini-ITX Chassis.
Download link for this setting:
[ftp://ftp.ts.fujitsu.com/pub/Mainboard-OEM-Sales/Products/Accessories/Industrial-Mini-ITX-Chassis/Adjusted Fan Setting D2963-S/](ftp://ftp.ts.fujitsu.com/pub/Mainboard-OEM-Sales/Products/Accessories/Industrial-Mini-ITX-Chassis/Adjusted_Fan_Setting_D2963-S/)

All relevant System Monitoring parameters can be customized via SilentFanConfig-Tool!

SilentFanConfig: Customize System Monitoring

- **Windows-based Configuration Tool**

ftp://ftp.ts.fujitsu.com/pub/Mainboard-OEM-Sales/Products/Mainboards/Industrial&ExtendedLifetime/D2963-S/IndustrialTools_D2963-S/SilentFanConfigManager/

- Use SilentFanConfig to adjust the required settings.
- As result, SilentFanConfig creates a BIOS configuration file. Save file as "smco.in"
- Afterwards you have to use the DOS-tool "SMCO" to flash the new fan settings into the BIOS.
- Copy smco.exe and smco.in to the DOS boot medium (USB-stick or USB- floppy or harddisk with DOS), boot on target platform and run following operation: smco smco.in
- New settings are written permanently to system BIOS



Note: SilentFanConfig V1.6 or higher required for D2963-S

D2963-S: SilentFanConfig (1)

Basic Fan Settings

Adjust minimum fan startup speed

Enable/disable fan speed control

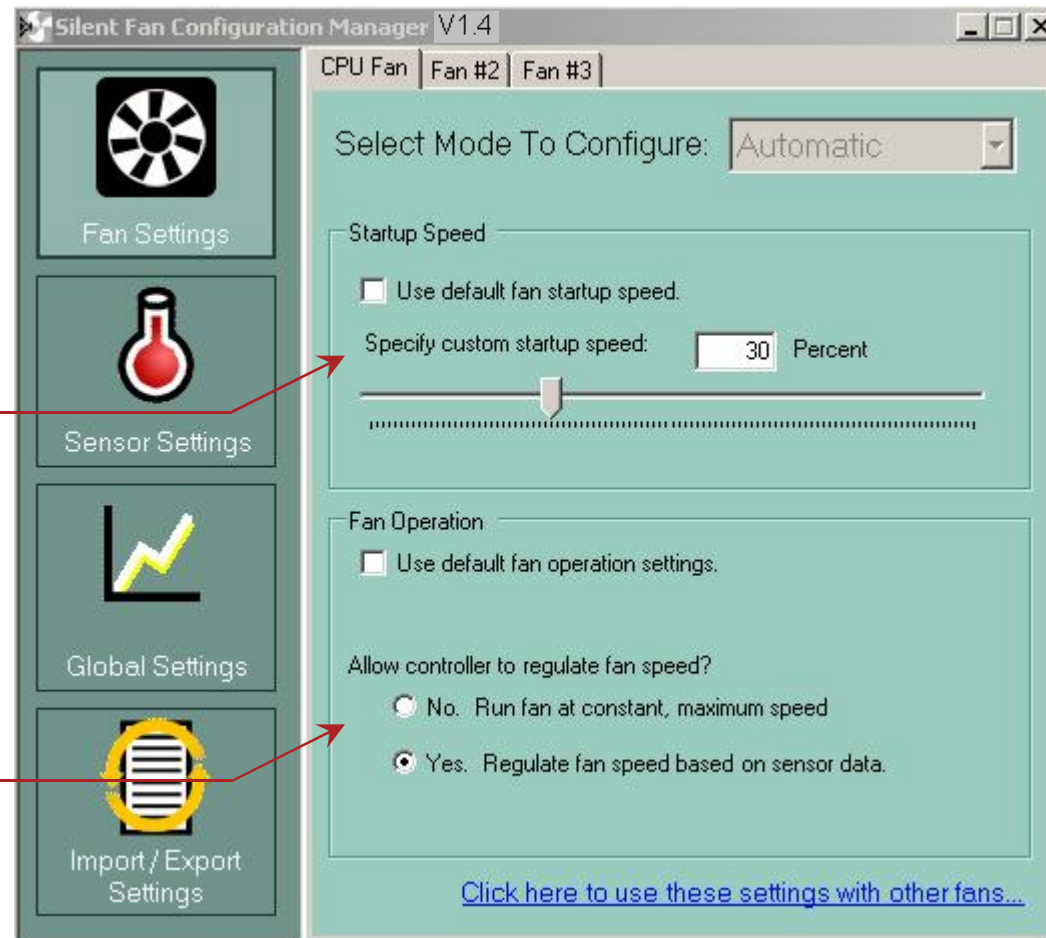

D2963-S: SilentFanConfig (2)

Basic Sensor Settings

Adjust related temperature settings

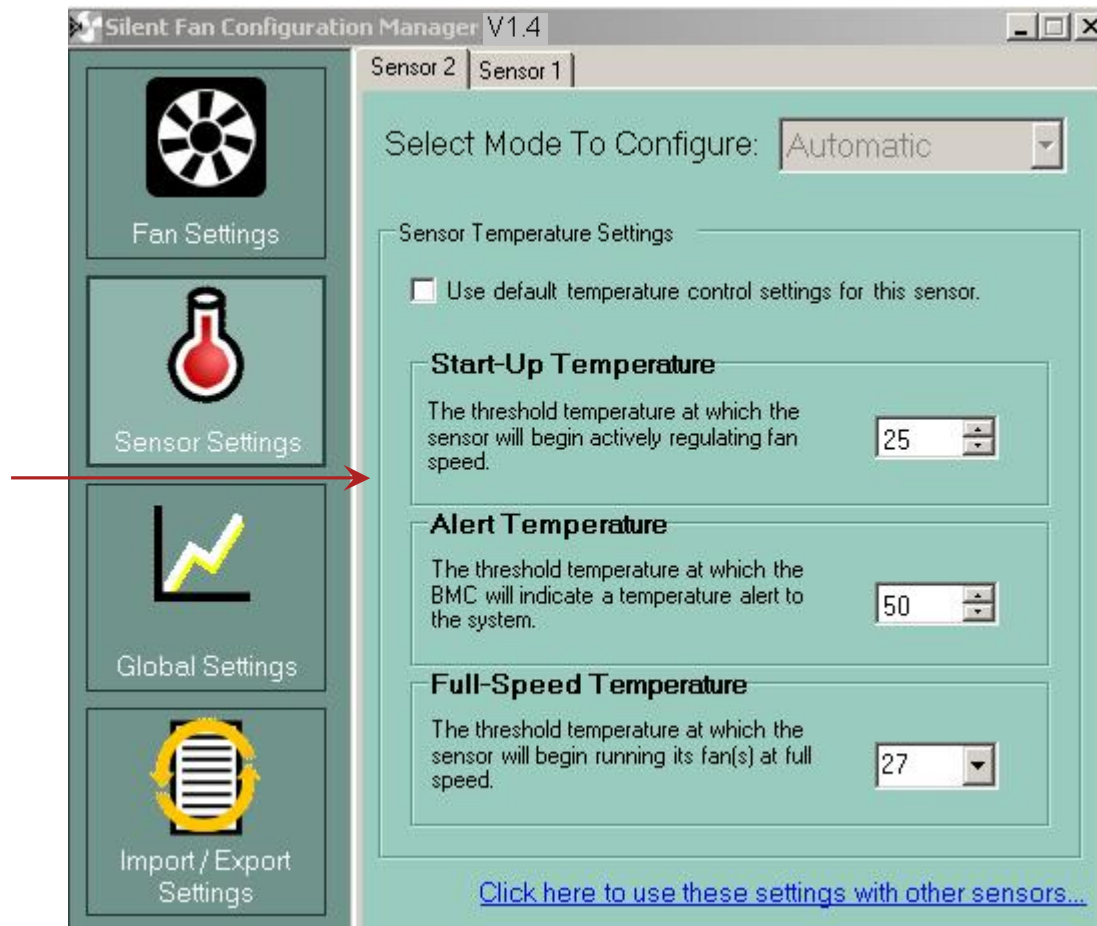

D2963-S: SilentFanConfig (3)

Global Settings

Adjust minimum fan speed
(Condition for "Fan removed")

Adjust sensor / fan influence

Note: Due to safety reasons the
CPU sensor always influences
Fan 1 (CPU)!

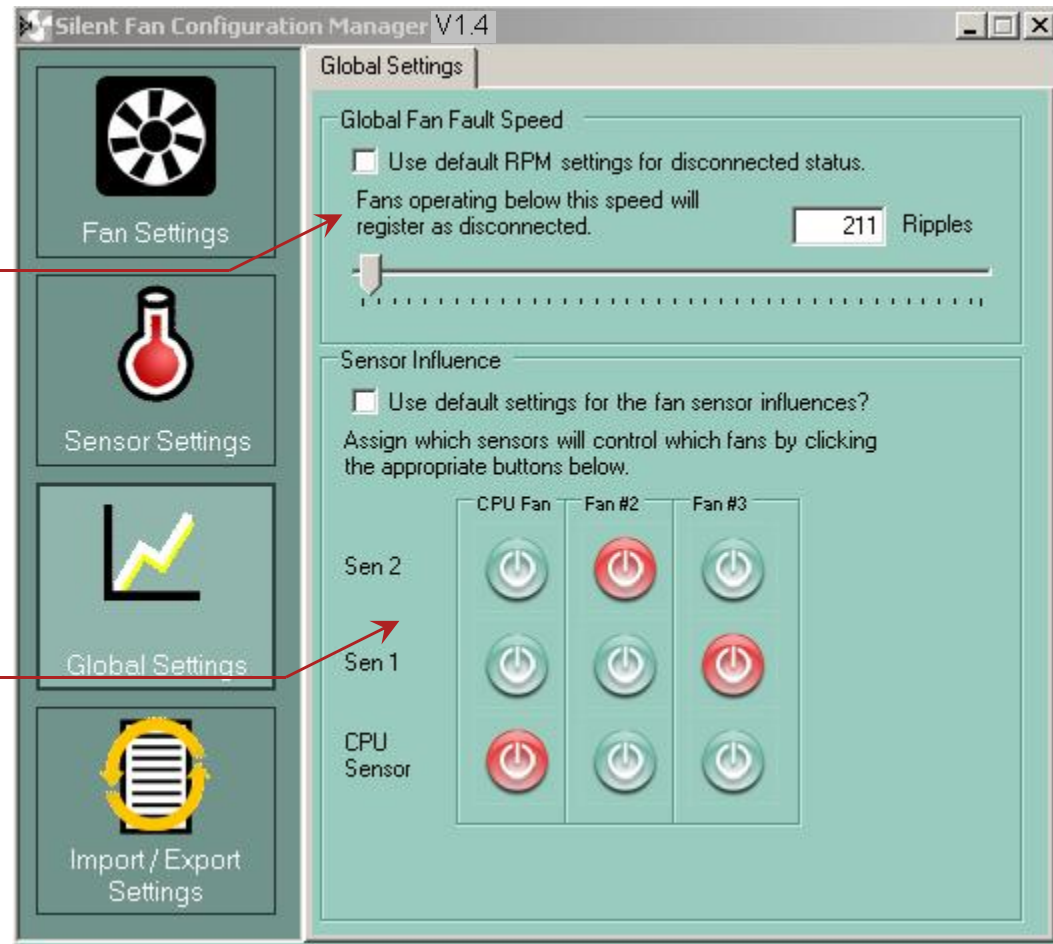

D2963-S: SilentFanConfig (4)

Import/Export Settings

Create configuration file "smco.in"
for additional SMCO flash tool (DOS-based).
Customized System Monitoring settings
can be flashed permanently to system BIOS.

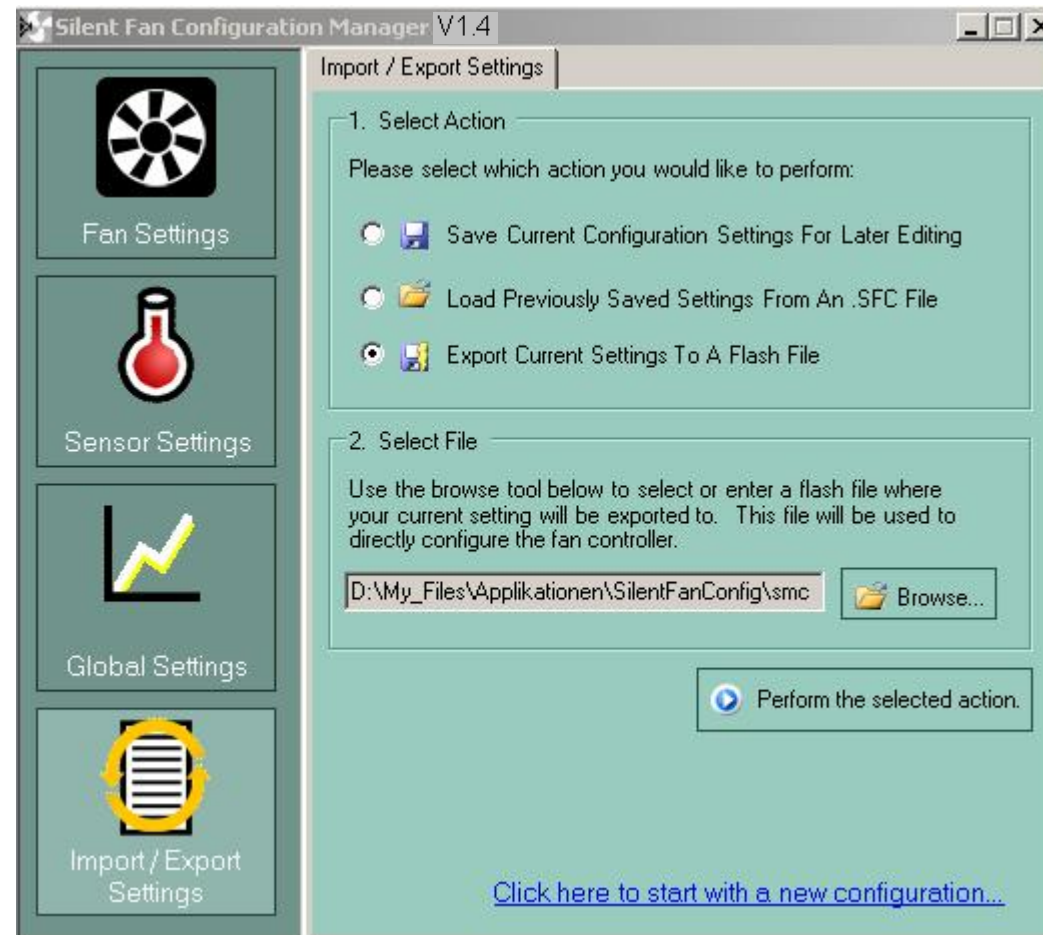

Thermography D2963-S

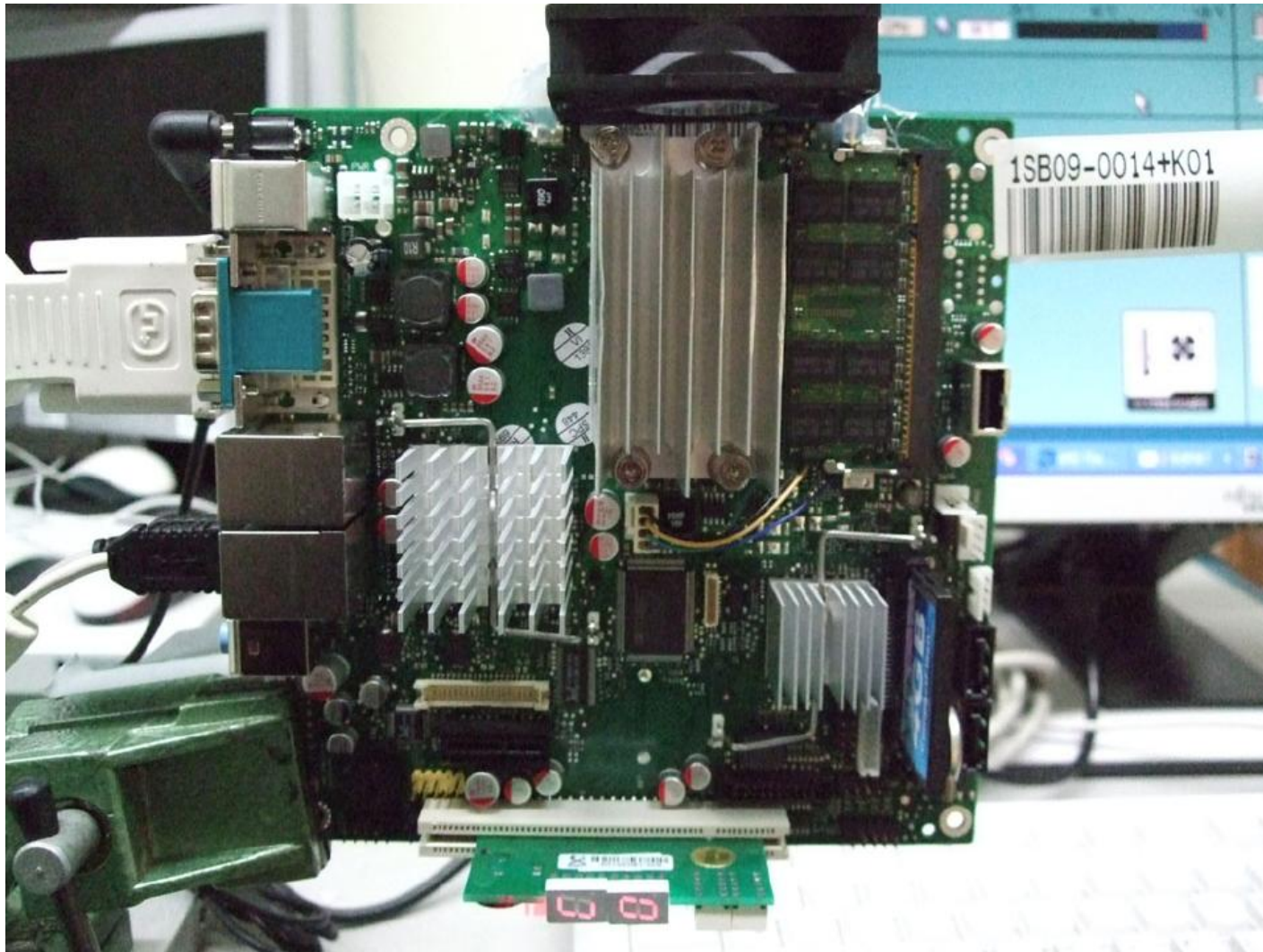

Thermography D2963-S (Front)

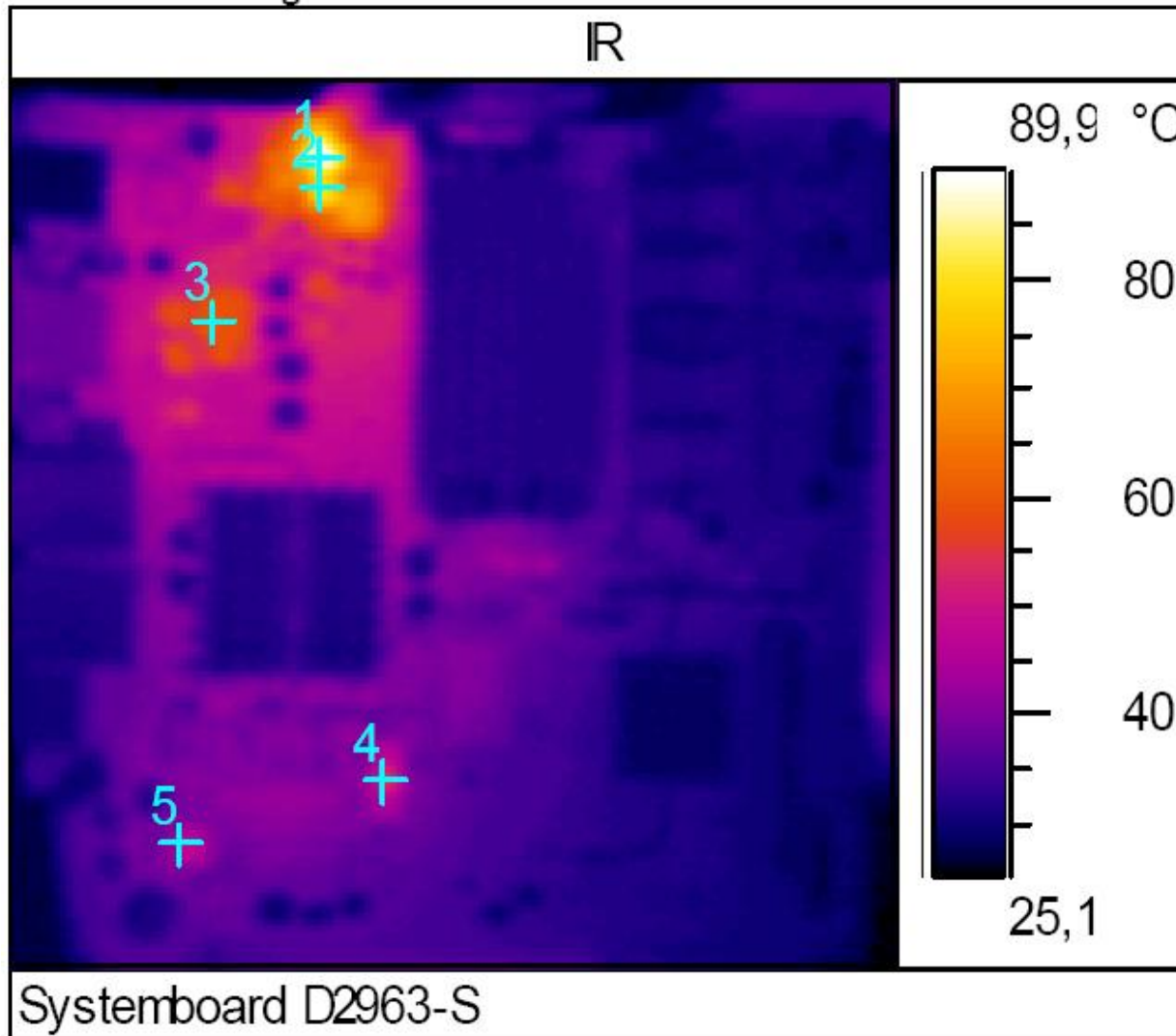

SCANNER-DATEN

Scanner Type	THV470
SWB	
Serial Number	75128
Level	586
Sens	6
Blende	0
Filter	NOF
Optik	20

BILD OBJ. PAR.

Emissionsfaktor	0,95
Umg.-Temp.	23,0 °C
Atm.-Temp.	23,0 °C
Objekt Dist.	1,0 m
Transmission	0,99

Temp.

SP01	>89,9 °C	V1301
SP02	80,7 °C	V1300
SP03	59,7 °C	L1650
SP04	54,0 °C	D1900
SP05	47,2 °C	D7100

Thermography D2963-S (Rear)

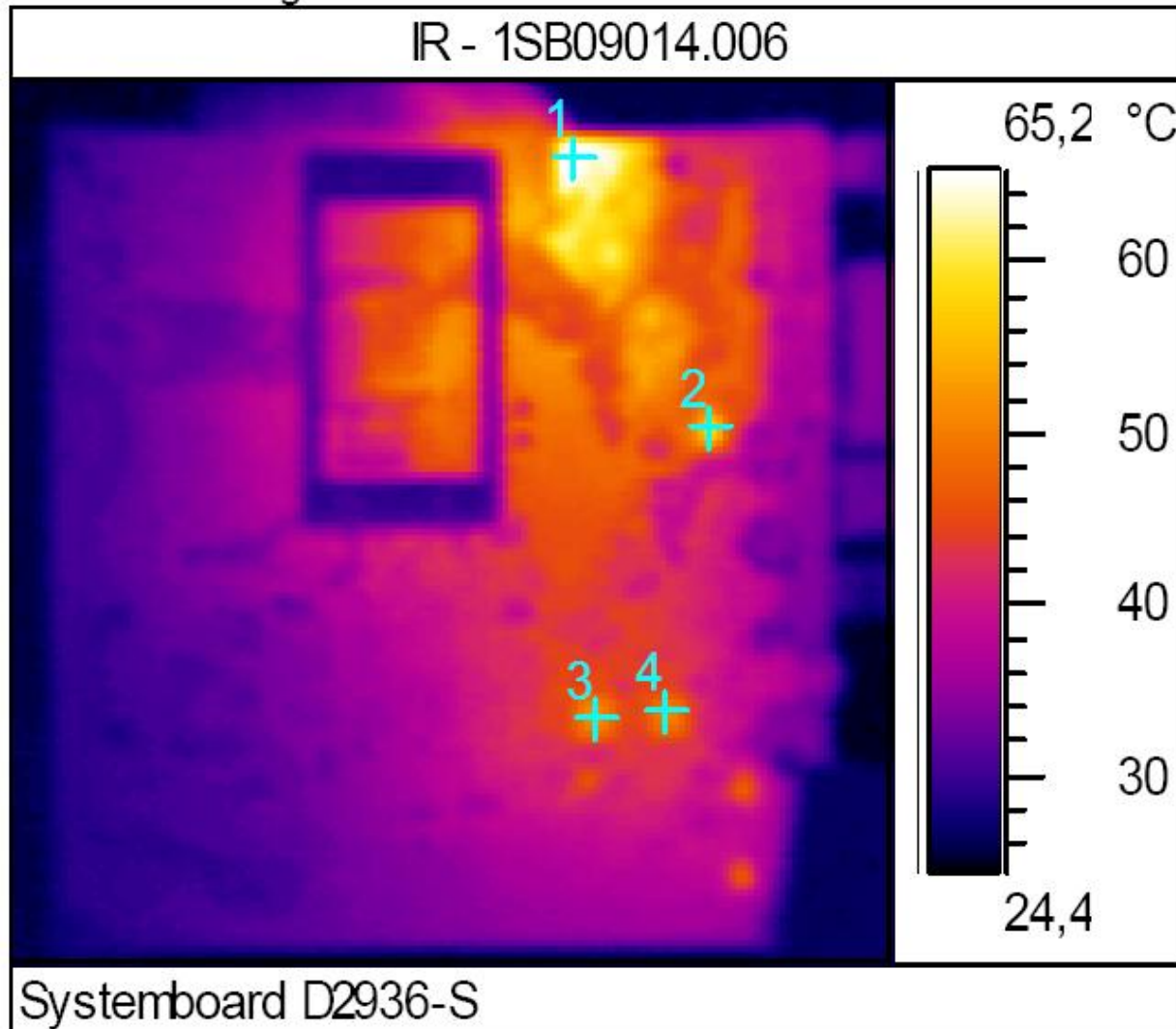

SCANNER-DATEN

Scanner Type THV470
SWB
Serial Number 75128
Level 358
Sens 5
Blende 0
Filter NOF
Optik 20

BILD OBJ. PAR.

Emissionsfaktor 0,95
Umg.-Temp. 23,0 °C
Atm.-Temp. 23,0 °C
Objekt Dist. 1,0 m
Transmission 0,99

Temp.

SP01	>65,2 °C	V1301 backside
SP02	58,2 °C	D4301
SP03	51,1 °C	D9000
SP04	50,8 °C	D9500

Climatic chamber test D2963-S

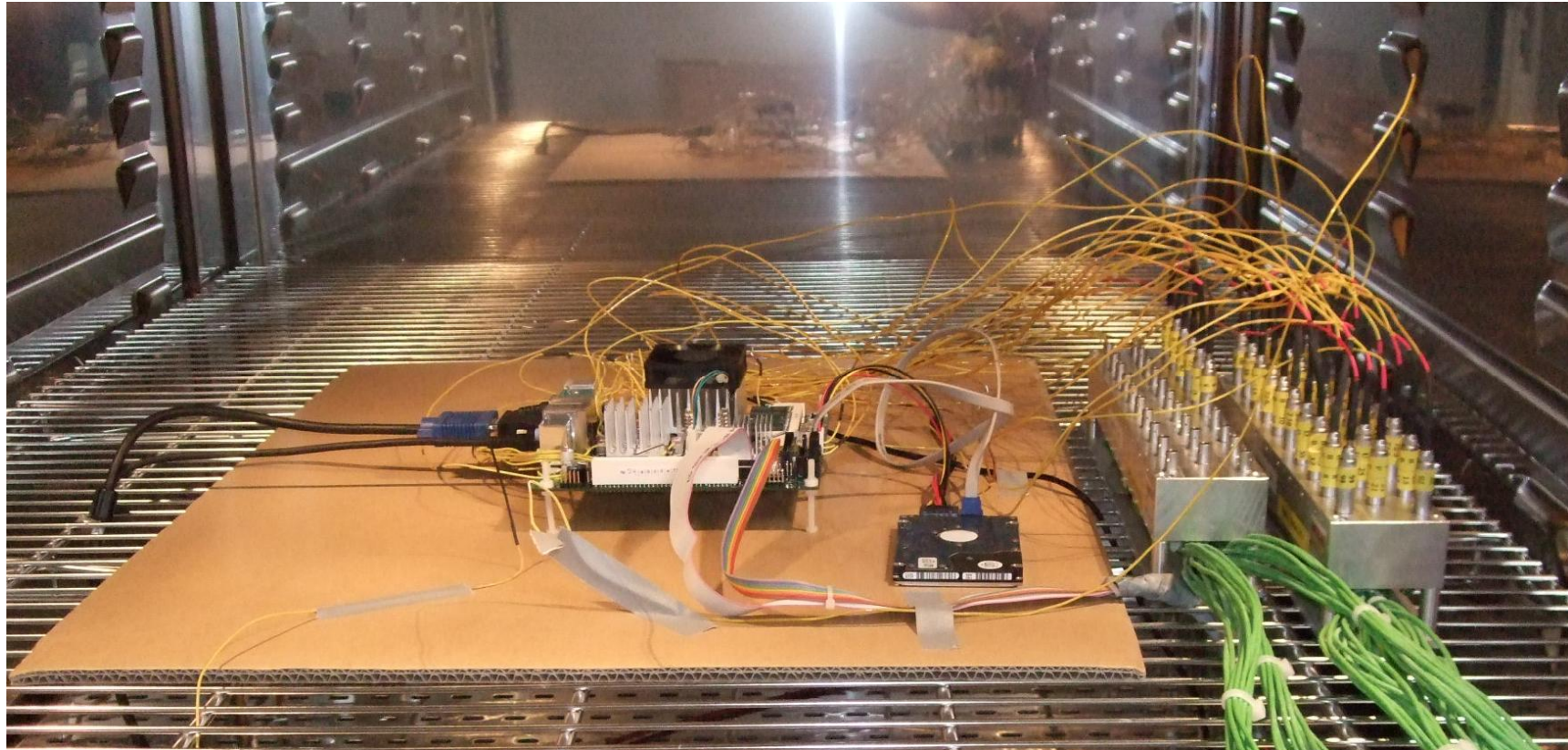

D2963-S with thermo couples for all critical components

Temperature Reference Points

Operating Conditions:
Circulating air max. 60° C
Usage 24h / 7 days

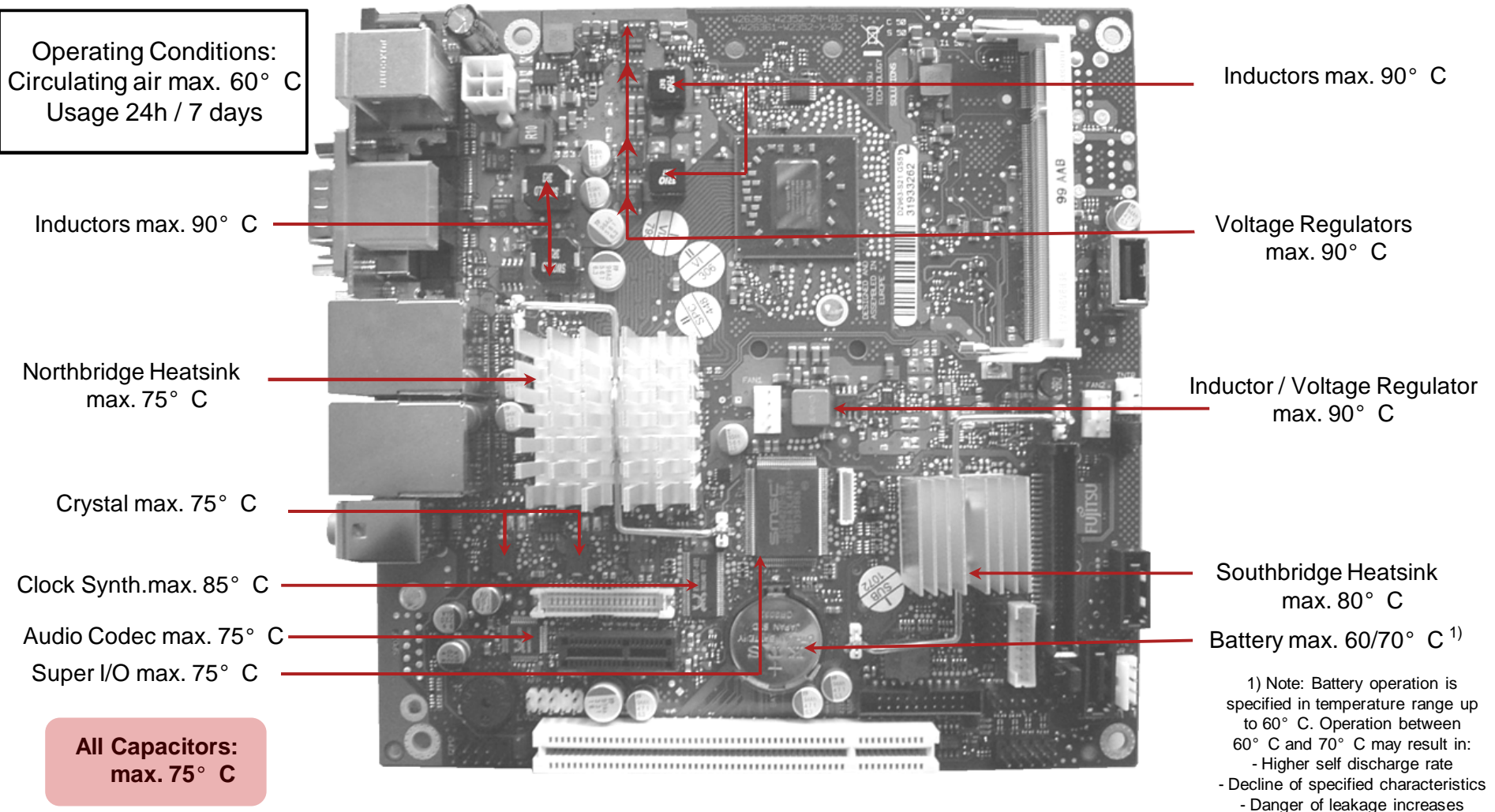

Reference Point Limit Temperatures (Component Surface) must not be exceeded!

Temperature Reference Points

Operating Conditions:
Circulating air max. 60° C
Usage 24h / 7 days

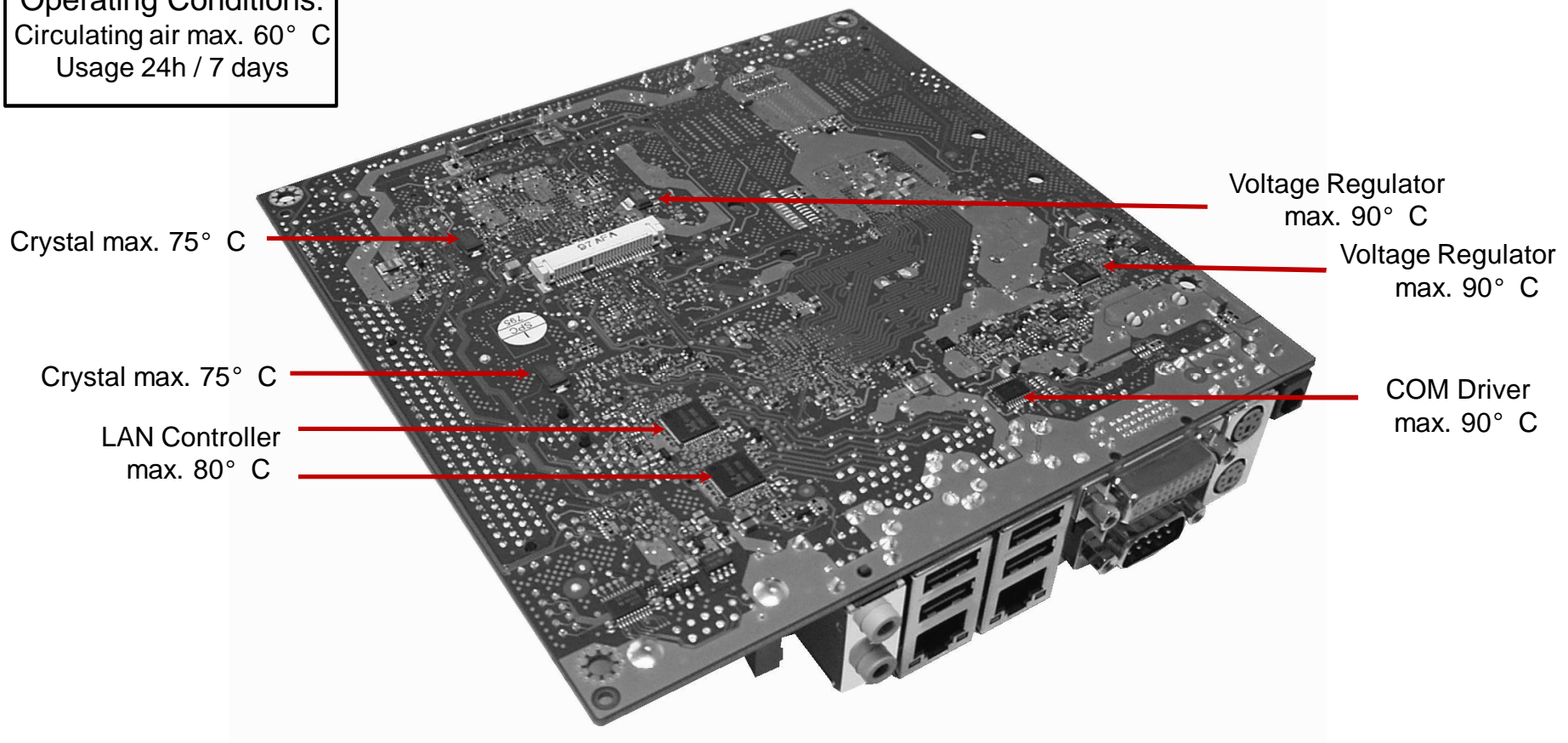

Reference Point Limit Temperatures (Component Surface) must not be exceeded!

Processor Excess Temperature Protection

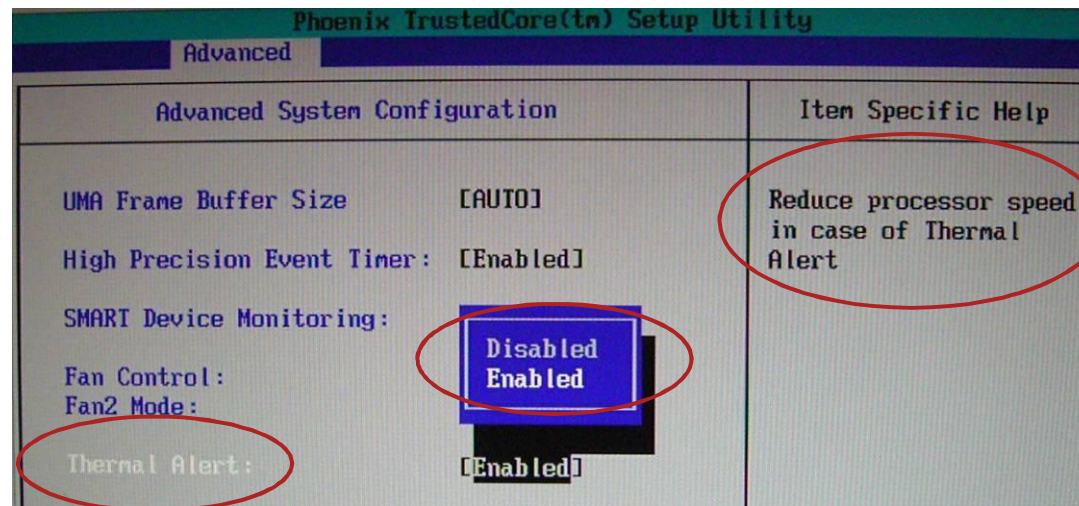

If the processor temperature exceeds the internal Alert temperature level (~ 100° C; exact level depends on processor), the onboard electronics forces the processor to throttle down (“ProcHot”) in order to reduce the power consumption and prevent the system from damage. The processor performance will be reduced to ~ 50%.

Note: This performance compensation will not be reset automatically after the processor has reached its specified temperature range again, but will remain active until the system is shut down or set to S3 (Standby) or S4 (save to disk).

Due to reliability reasons this option is <Enabled> in BIOS Setup by default.

If this option is disabled, the system will shutdown in case of excess processor temperature when reaching a limit of ~ 125° C

Mainboard Power Consumption

- AC Mains Power Consumption

AC Mains Power Consumption

	D2963-S1 Sempron 200U, 1GHz single / max. 8W 1GB RAM, HDD 2.5" SATA, Win XP AC adapter E557-V55 @230V	D2963-S2 Athlon L325, 1.5GHz dual / max. 18W 1GB RAM, HDD 2.5" SATA, Win XP AC adapter E557-V55 @230V
Pure MS-DOS ¹⁾	~ 23W	~ 30W
Windows XP "Idle"	~ 15W	~ 16W
Windows XP Full Load ²⁾	~ 20W	~ 33W
Windows XP „S3“ („Standby“) ³⁾	< 1W	< 1W
Windows Shutdown „S5“ ³⁾	< 1W	< 1W

1) Boot from USB stick

2) Windows XP, 100% processor load (AMD stress tool)

3) Depends on power supply efficiency @ minimum output power, BIOS settings and LAN configuration

Special Features

- Mainboard Watchdog
- Harddisk Security

Mainboard Watchdog

- Watchdog feature provides secure system behaviour in case of software crash

- System shuts down or
- System reboots



Example:

Printer Server (unattended)

- Specific SW application re-triggers watchdog timer every 10 seconds

-If the printer software hangs, the re-trigger application will no longer be active, and the watchdog forces the system to reboot

- After reboot, printer software is available again

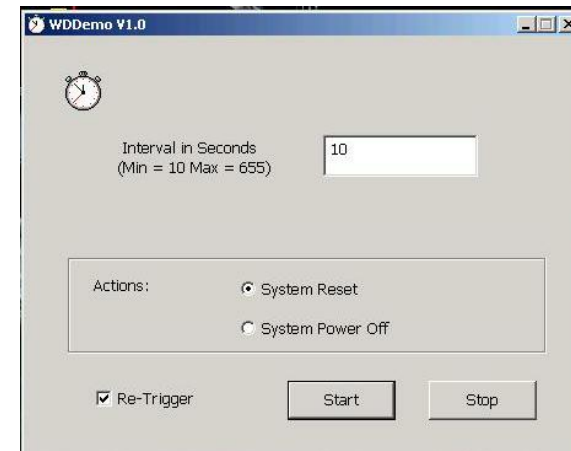

(Demo Application)

Note: Detailed programming info about the Watchdog feature is available in the OEM mainboard specification.

A Windows-based API is available for easy implementation of the GPIO features (included in SystemMonitoring API)

ftp://ftp.ts.fujitsu.com/pub/Mainboard-OEM-Sales/Products/Mainboards/Industrial&ExtendedLifetime/D2963-S/IndustrialTools_D2963-S/BMC_Management-Controller-API/

Harddisk Security

• Password Protection for Harddisk

- Password Entry on each Boot or
- Silent Boot from Protected Harddisk



à Second option useful for unattended system to ensure OS boot w/o any user interaction

Note: Harddisk protected by HDD password cannot be used any more if password gets lost. Keeps your SW IP secure within your system!

```
SATA Port 1 [ST3808110AS-(S2)]

Total Sectors:      156301408
Maximum Capacity:  80 GByte

Multi-Sector Transfers: [16 Sectors]
LBA Mode Control:    [Enabled]
32 Bit I/O:         [Enabled]
Transfer Mode:      [FPIO 4 / DMA 2]
Ultra DMA Mode:    [Mode 6]
SMART Monitoring:  Enabled
Firmware:          3.AAE

Password Status:    Installed
Change Password:   [Press Enter]
Password Entry on Boot: [Enabled]
Master Password:   [Enabled]
```

Silent Boot - Option →

Operating System Support

- Windows ® XP / VISTA / Windows 7
- Windows® XP Embedded
- Linux / Embedded Linux

Support for Windows® XP / VISTA / Windows 7

- **Mainboard D2963-S is designed according to the Microsoft Guidelines for Windows XP, Windows VISTA and Windows 7**
- **MS certified drivers are available via OEM DU-DVD, OEM FTP Server and FTS Website**



Support for Windows® XP Embedded



- **Conditions**

- Customer is familiar with XP Embedded & Target Designer / Component Designer
- Customer creates specific XP Embedded SW installation at his own responsibility & risk

- **FTS provides Board Support Package**

(SLD files incl. drivers for D2963-S onboard components)

- Drivers contain english language version
- SLD files have no license restrictions
- Complete BSP will be available for download:

ftp://ftp.ts.fujitsu.com/pub/Mainboard-OEM-Sales/Products/Mainboards/Industrial&ExtendedLifetime/D2963-S/Drivers_D2963-S/

Support for Linux OS (preliminary)

	Basic OS Installation	HDD / DVD Read/Write Access	Graphics	LAN	2 nd LAN	Sound
openSUSE 10.3, 32 Bit	OK	OK	OK ¹⁾	OK ³⁾	OK ³⁾	OK ³⁾
openSUSE 10.3, 64 Bit	OK	OK	OK ¹⁾	OK ³⁾	OK ³⁾	OK ³⁾
openSUSE 11.0, 32 Bit	OK	OK	OK ¹⁾	OK	OK	OK
openSUSE 11.0, 64 Bit	OK	OK	OK ¹⁾	OK	OK	OK
SUSE Linux Enterprise 10 SP2, 32 Bit	OK	OK	OK	OK ³⁾	OK ³⁾	OK ³⁾
SUSE Linux Enterprise 10 SP2, 64 Bit	OK	OK	OK	OK ³⁾	OK ³⁾	OK ³⁾
Fedora 9, 32 Bit	OK	OK	OK ²⁾	OK	OK	OK
Fedora 9, 64 Bit	OK	OK	OK ²⁾	OK	OK	OK
Red Hat Enterprise Linux 5.2, 32 Bit	OK	OK	OK	OK ³⁾	OK ³⁾	OK ³⁾
Red Hat Enterprise Linux 5.2, 64 Bit	OK	OK	OK	OK ³⁾	OK ³⁾	OK ³⁾
Debian Etch, 32 Bit (netinst) ⁴⁾	Failed	Failed	Not testable	Failed	Failed	Not testable
Debian Etch, 64 Bit (netinst)	Failed	Failed	Not testable	Failed	Failed	Not testable
Debian Lenny, 32 Bit (netinst)	OK	OK	OK	OK	OK	OK
Debian Lenny, 64 Bit (netinst)	OK	OK	OK	OK	OK	OK
Ubuntu 7.1, 32 Bit	OK	OK	OK	OK ³⁾	OK ³⁾	OK ³⁾
Ubuntu 7.1, 64 Bit	OK	OK	OK	OK ³⁾	OK ³⁾	OK ³⁾
Ubuntu 8.10, 32 Bit	OK	OK	OK	OK	OK	OK
Ubuntu 8.10, 64 Bit	OK	OK	OK	OK	OK	OK

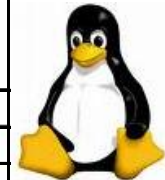

- 1) See installation hints: <http://www.suse.de/~sndirsch/ati-installer-HOWTO.html>
- 2) Only preinstalled ATI driver, driver kit provided via ati.amd.com isn't working
- 3) Tested with compiled kernel 2.6.27.5
Note: Note: If standard kernel is used, LAN cable must not be connected before LAN module is loaded
- 4) Note "Debian Etch": No official support for Debian by AMD/ATI, but working installation is possible
 - After basic installation, system shows several boot errors (= Kernel 2.6.18-5-486)
 - Run Debian updater (Kernel update) to resolve boot errors (= Kernel 2.6.18-6-486)
 - Install ATI graphics driver <http://ati.amd.com/support/driver.html>
("Linux x86 -> Integrated/Motherboard -> Radeon Xpress 1250")

**Unofficial Wiki for ATI
Linux Drivers**
http://wiki.chtml.com/index.php/Main_Page

Support for Embedded Linux (preliminary)

- FTS provides free demo BSP for Embedded Linux



- Download link

ftp://ftp.ts.fujitsu.com/pub/Mainboard-OEM-Sales/Products/Mainboards/Industrial&ExtendedLifetime/D2963-S/Drivers_D2963-S/



FUJITSU